

# ROBTECH

高效

专业

诚信

PROFESSIONAL MANIPULATOR PARTS SUPPLIER

**YOUR BESTPARTNER**

您最佳的合作伙伴





## Công ty TNHH Kỹ Thuật Công Nghệ Robtech

🏠 : T2/D3B/52 Tổ 2, Khu Phố Bình Thuận, Phường Thuận Giao, Thành Phố Thuận An, Tỉnh Bình Dương

🏠 : 762/3 Quốc Lộ 1A, Phường Bình Hưng Hòa B, Quận Bình Tân, Thành Phố Hồ Chí Minh

## Robtech Technical Technology Company Limited

🏠 : 总部: 越南平阳省顺安市顺交坊平顺街道 T2/D3B/52

🏠 : 胡志明: 越南胡志明平新郡平兴和B 1A 国道762/3

☎ : 0898 325 510

✉ : info@thailongvietnam.com

✉ : robtech@thailongvietnam.com

🌐 : www.thailongvietnam.com

🌐 : www.robtech.com.vn



合作共赢

WIN-WIN



齿条侧姿组 JDCZ-3240TB

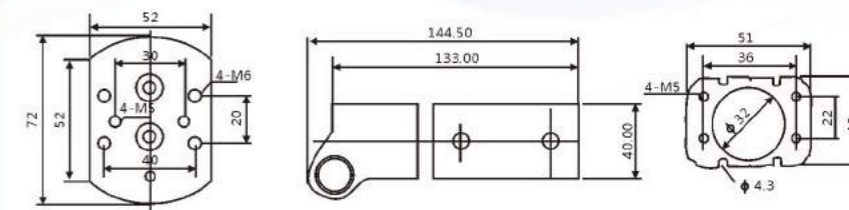

产品型号: JDCZ-3240TB 重量: 0.9kg 可搬重量: 5kg



齿条侧姿组 JDCZ-3240

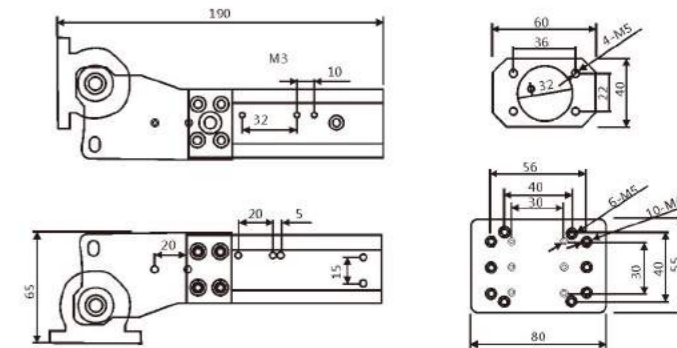

产品型号: JDCZ-3240 重量: 1.2kg 可搬重量: 5kg



侧姿组 JDCH-3240DL

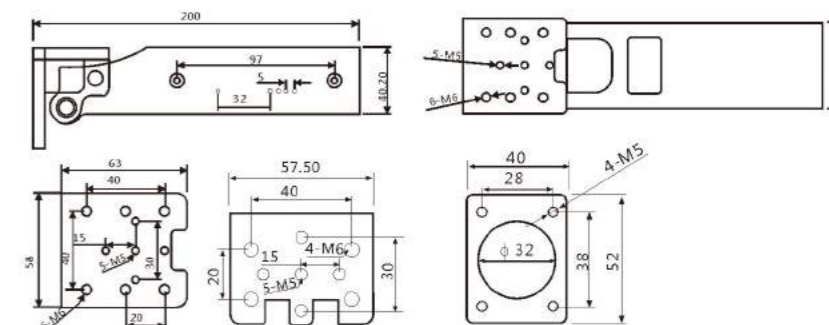

产品型号: JDCH-3240DL 重量: 1kg 可搬重量: 5kg



侧姿组 JDCH-4040DL

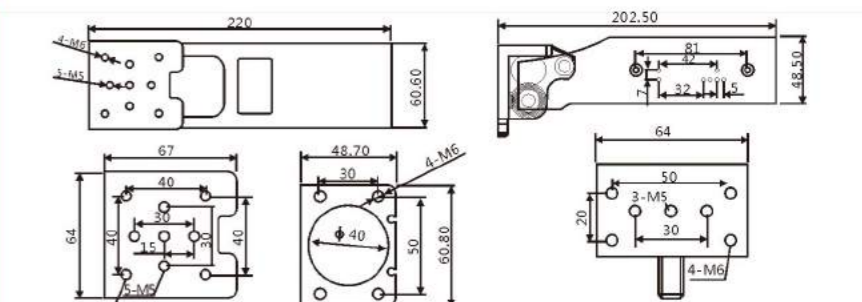

产品型号: JDCH-4040DL 安装孔: 30x50mm 重量: 1.3kg 可搬重量: 10kg



# 侧姿组系列

SIDE FUNDING GROUP SERIES

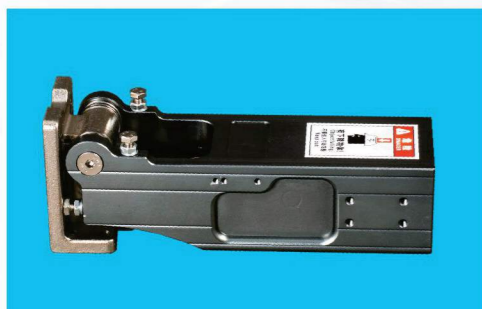

侧姿组 JDCH-4040DL

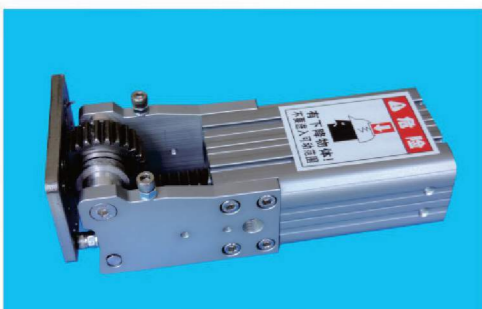
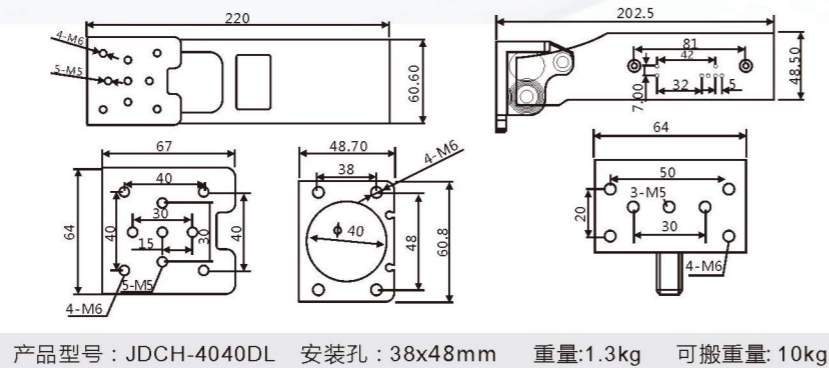

齿条侧姿组 JDCZ-4040

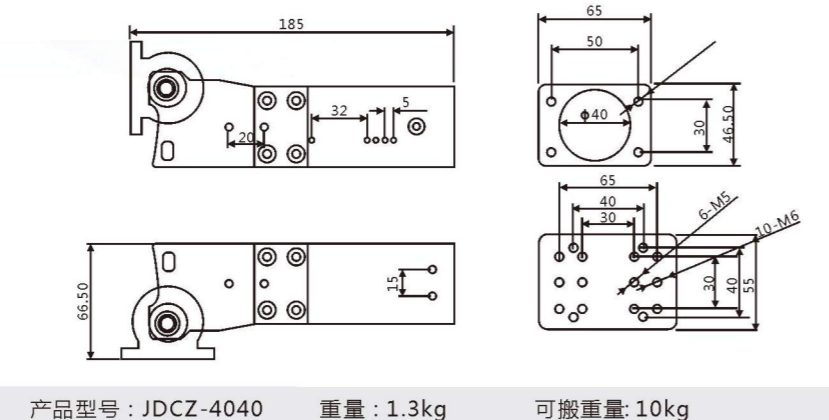

齿条侧姿组 JDCZ-5040

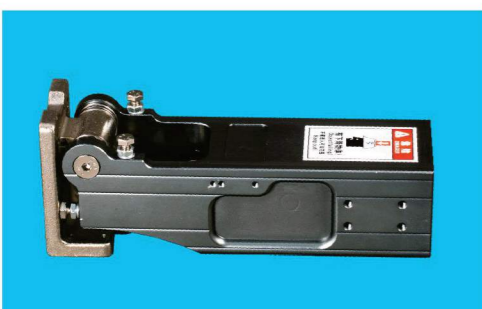
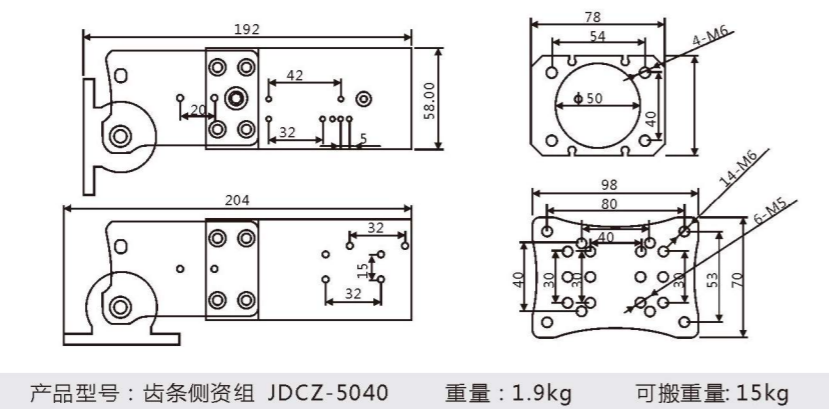

侧姿组 JDCH-5040DL

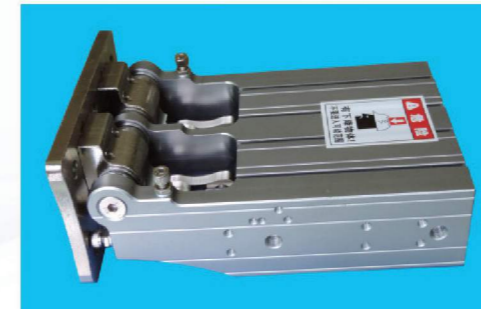
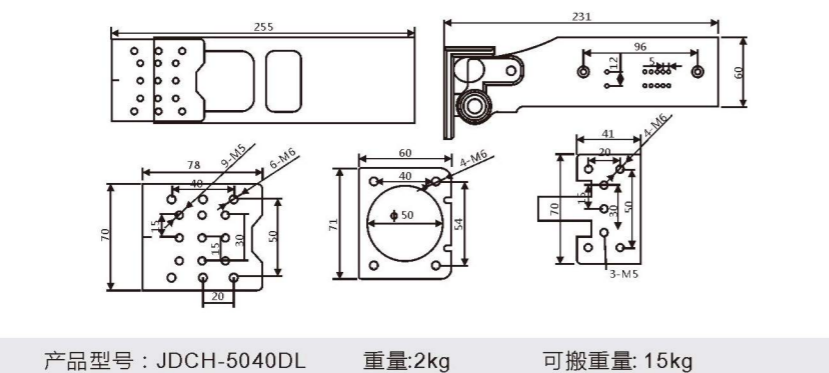

双缸侧姿组 JDCH2-5040

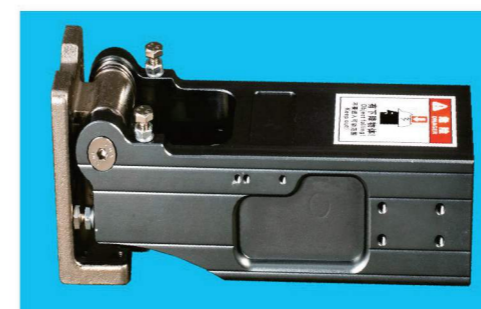
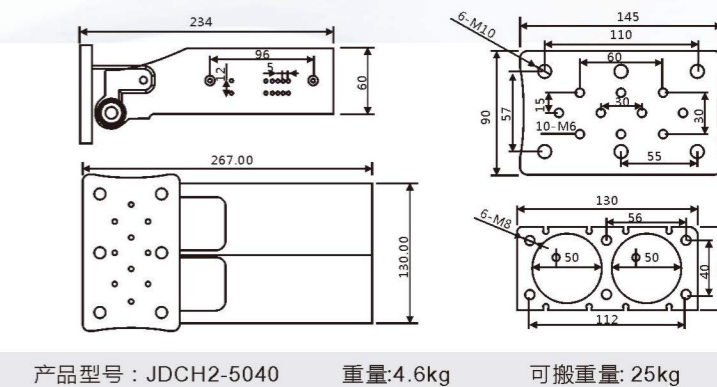

侧姿组 JDCH-6340DL

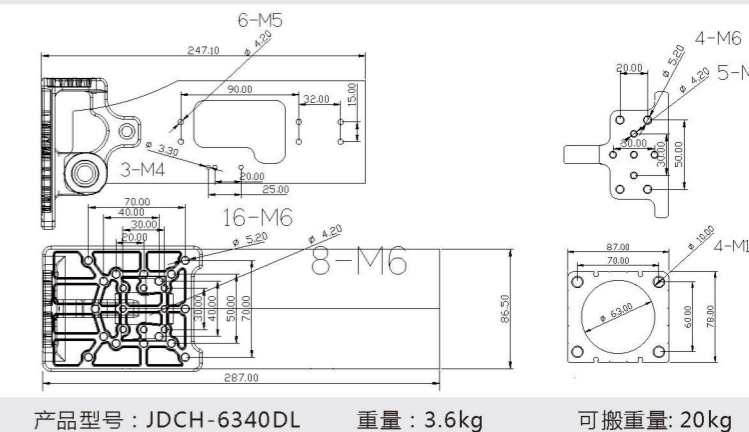

双缸侧姿组 JDCH2-6340

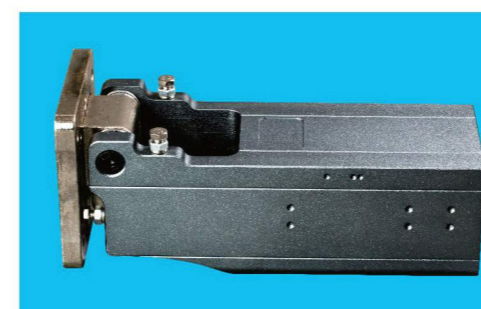
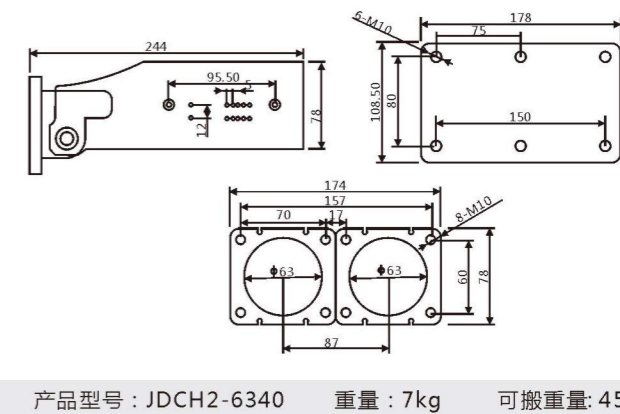

侧姿组 JDCH-8080

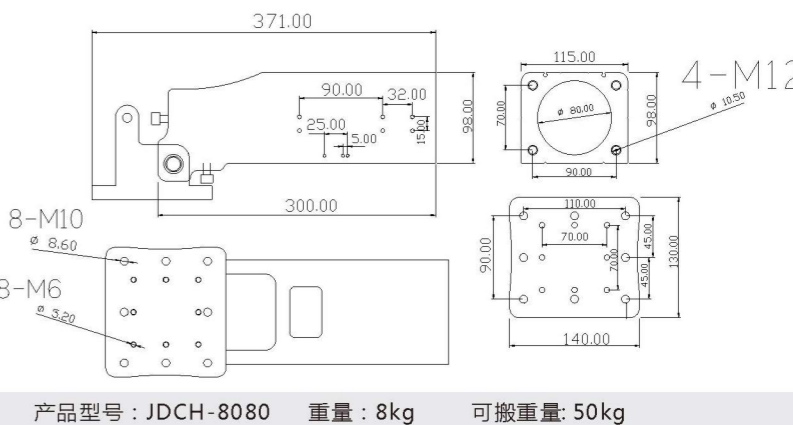



JD-1615S单动

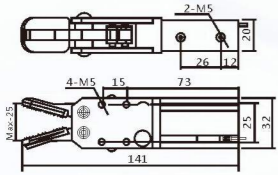

JD-1615D双动

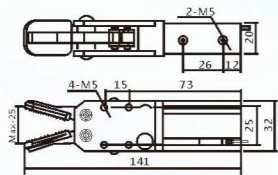

JD-2015S单动

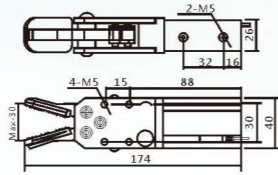

JD-2015D双动

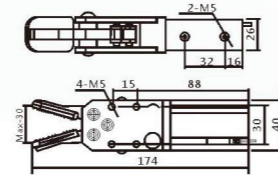

JD-1615DL

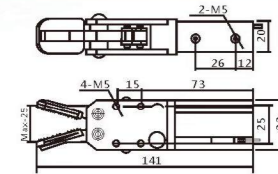

JD-2015DL

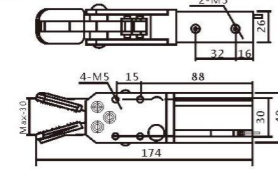

JD-2015DG

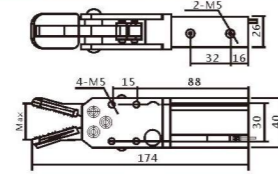

JD-2015DF

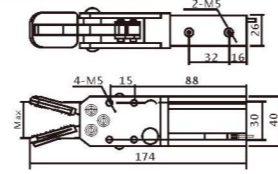

JD-1815S

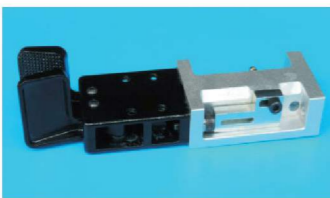
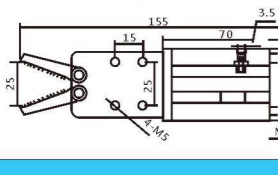

JD-1815SW

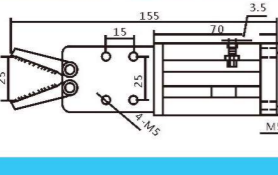

JD-1815S1

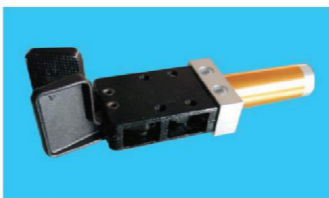
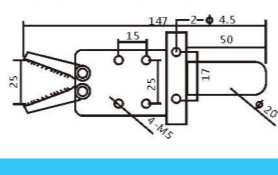

JD-1815S2

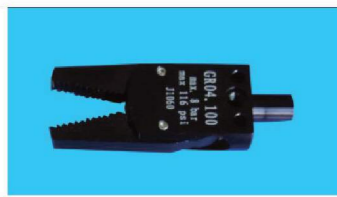
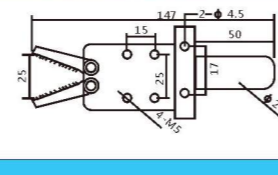

迷你夹具 A

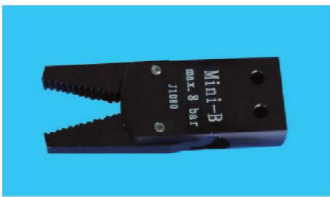
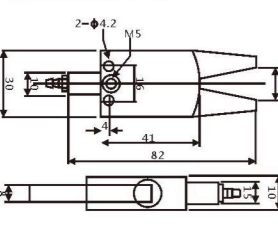

迷你夹具 B

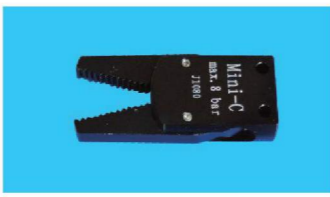
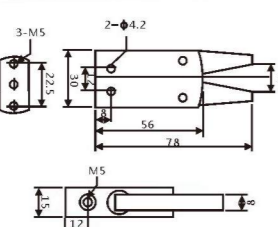

迷你夹具 C

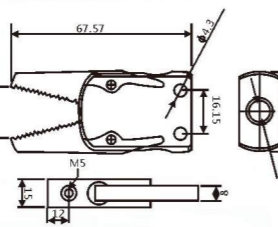

迷你夹具 D

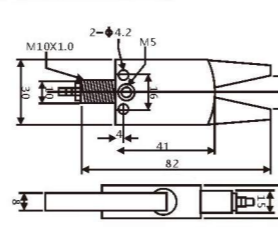

迷你夹具 E

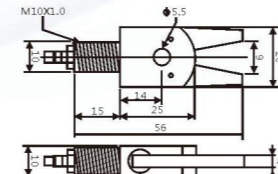

迷你夹具 F

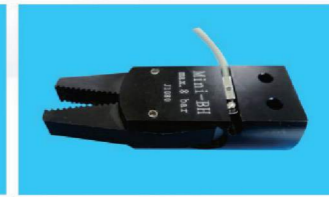
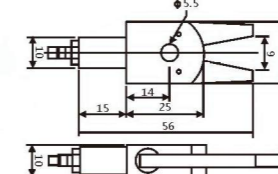

迷你夹具BH (带磁)

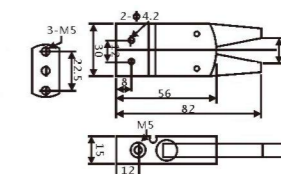

迷你夹具AH (带磁)

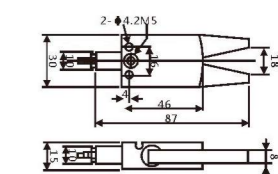

迷你夹具AK

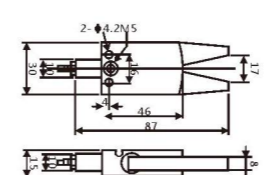

迷你夹具BK

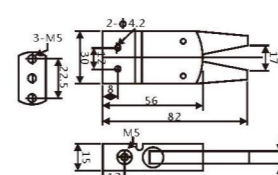

迷你夹具EM1-08

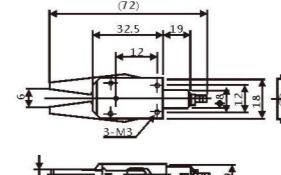

迷你夹具EM-08-C

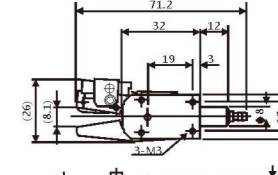

迷你夹具EM-12

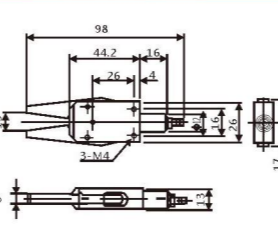

迷你夹具EM-12-C

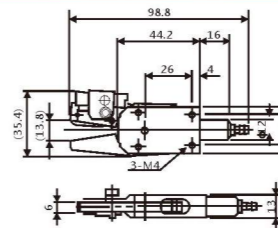

迷你夹具EX-20

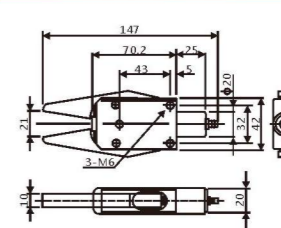

迷你夹具EX-20-C

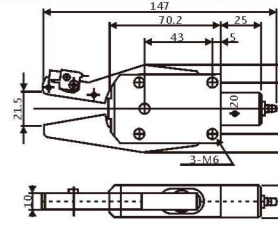

爪旋组 TX-90

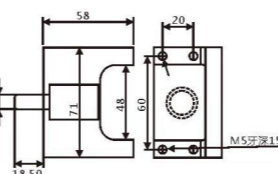

爪旋组 TX-180

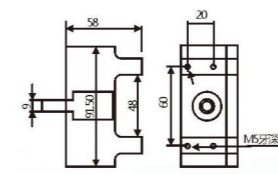

JD20F20夹具连接块



JD20F16夹具连接块



# 夹具系列

FIXTURE SERIES

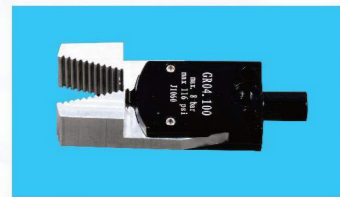

迷你夹具AL

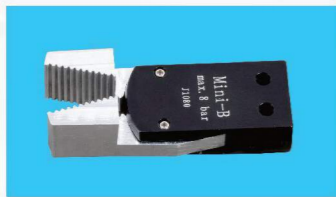

迷你夹具BL

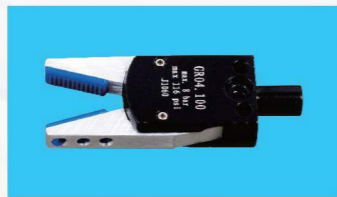

迷你夹具AG



迷你夹具BG



MHZ2-10S



MHZ2-16S

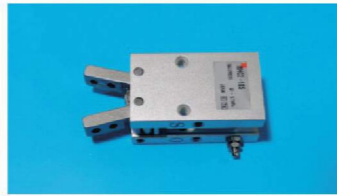

MHC2-10S



MHC2-16S



MHZ2-10D



MHZ2-16D



MHC2-10D



MHC2-16D



MHS3-25D



MHS3-32D



MHL2-10D



MHL2-16D

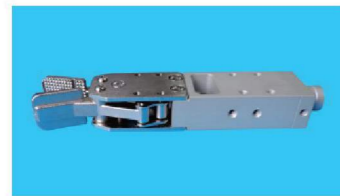

伟力夹具-A



伟力夹具-T

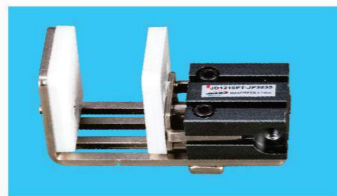

抱具-1210

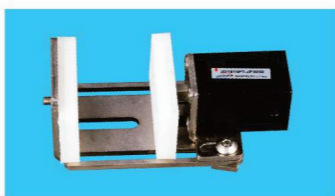

抱具-1815



JDZ2-12D



JDZ2-16D



车床换向夹爪 JDR2-30G32



车床换向夹爪 JDR2-30G40

# 抱具系列

HOLDING GEAR SERIES

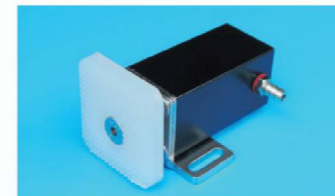

JD1815PT-JP3636



JD1815PT-JP3540



JD1815PT-JP3050



JD1815PT-JP3560



JD1815WD-JD3636

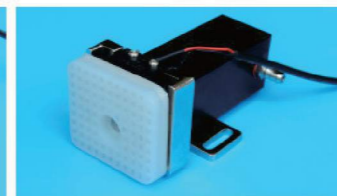

JD1815WD-JD3540

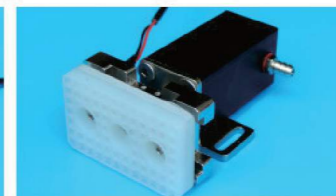

JD1815WD-JD3050



JD1815WD-JD3560



JD1815PT-JF3050



JD1815PT-JF3560



JD1820PT-JP3636



JD1820PT-JP3540



JD1815WD-JH3050



JD1815WD-JH3560

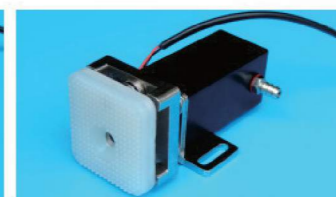

JD1820WD-JD3636



JD1820WD-JD3540



JD1820PT-JP3050

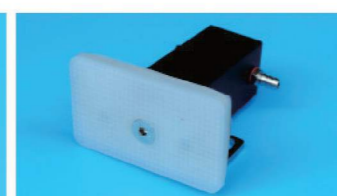

JD1820PT-JP3560



JD1820PT-JF3050



JD1820PT-JF3560

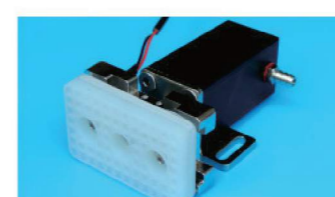

JD1820WD-JD3050



JD1820WD-JD3560



JD1820WD-JH3050



JD1820WD-JH3560



# 抱具系列

HOLDING GEAR SERIES

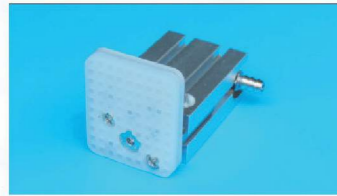

JD-1205PT

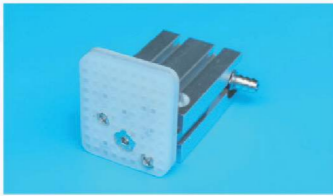

JD-1210PT



JD-1210PT-A



JD-1218PT

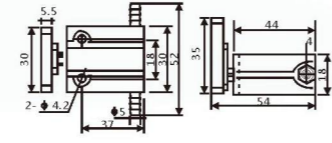
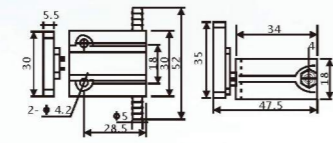
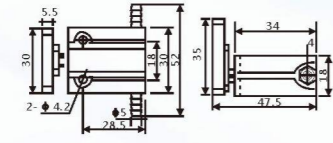
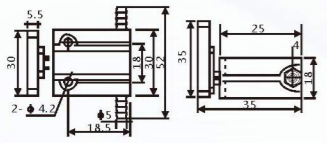

JD-1205WD

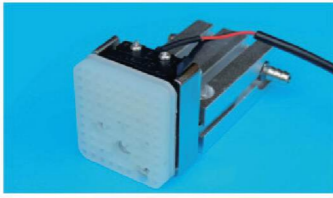

JD-1210WD



JD-1210WD-A

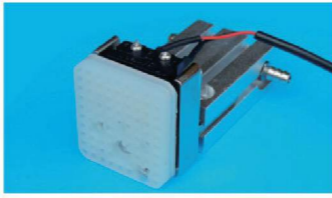

JD-1218WD

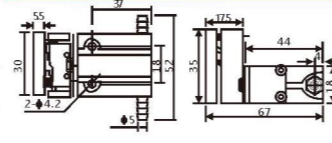
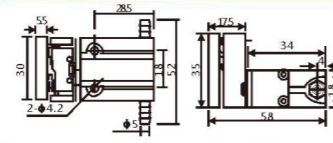
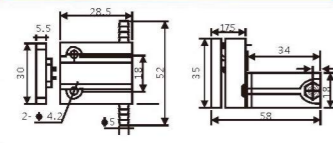
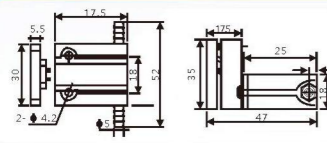

JD 1815

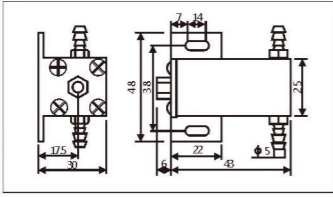

JD 1820

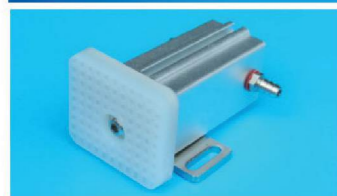
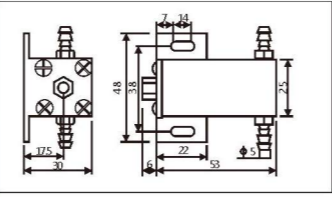

JD1810-CH带磁

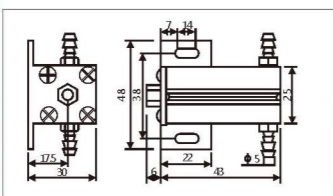

JD1815-CH带磁

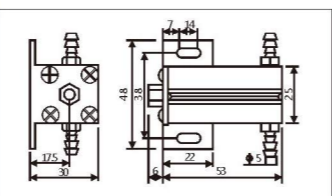

MCD-10

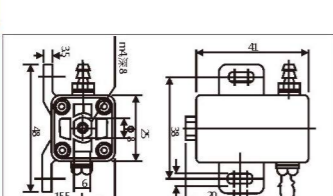

MCD-20

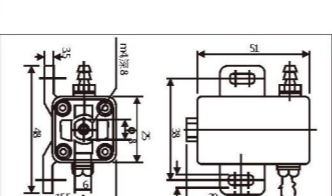

UMCD-5

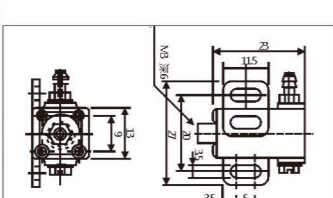

UMCD-10

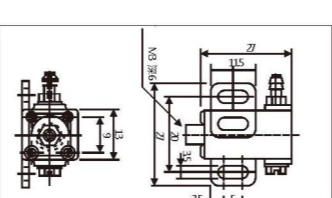

MCD-10PT-JP3050



MCD-10WD-JD3050



MCD-20PT-JP3050



MCD-20WD-JD3050

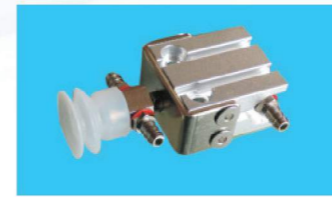

JD1210-Q



MCD-10Q



JD1815-Q



JD1820-Q



JD1210CH带磁



JD-XB10



JP-3035



JP-3035A

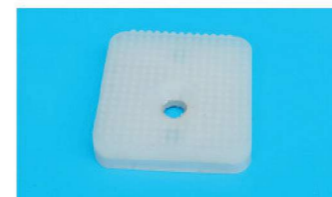

JP-3636



JP-3540



JP-3050

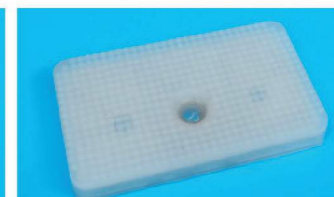

JP-3560



JF-3050

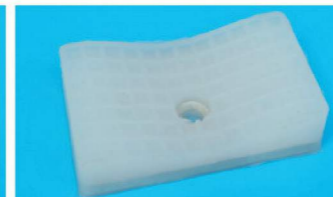

JF-3560

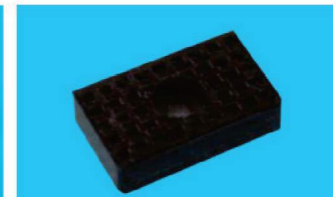

JP-1423



JP-XB



JD-3035



JD-3035A



JD-3636



JD-3540



JD-3050



JD-3560



JH-3050



JH-3560



▼ 铝金具系列

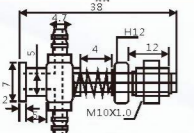

VFIL-SS-5 铝小头金具

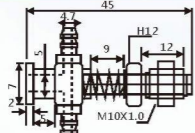

VFIL-SS-10 铝小头金具

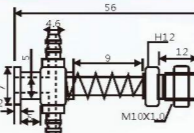

VFIL-SS-20 铝小头金具

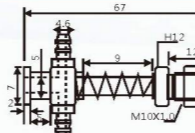

VFIL-SS-30 铝小头金具

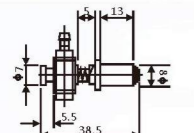

VFIL-SS-5-P8 铝小头金具

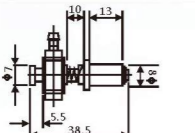
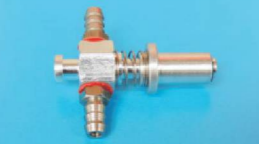

VFIL-SS-10-P8 铝小头金具

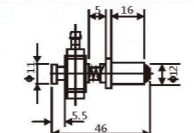

VFIL-S-5-P12 铝大头金具

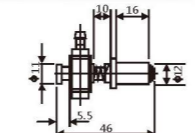

VFIL-S-10-P12 铝大头金具

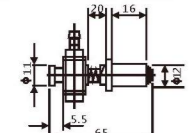

VFIL-S-20-P12 铝大头金具

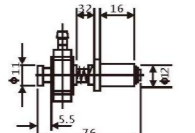

VFIL-S-30-P12 铝大头金具

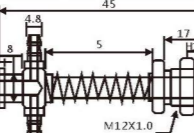

VFIL-S-5 铝大头金具

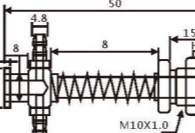

VFIL-S-10A 铝大头金具

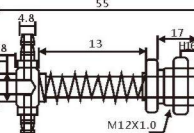

VFIL-S-10 铝大头金具

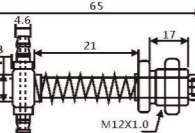

VFIL-S-20 铝大头金具

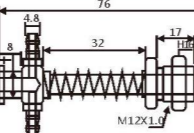

VFIL-S-30 铝大头金具

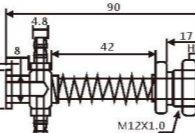

VFIL-S-40 铝大头金具

▼ 天行金具系列

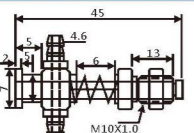

JD07-1045 小头金具

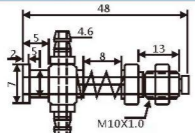

JD07-1048 小头金具

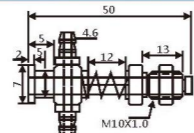

JD07-1050 小头金具

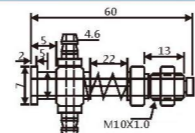

JD07-1060 小头金具

▼ 天行金具系列

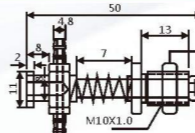

JD11-1050 大头金具

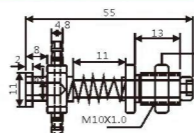

JD11-1055 大头金具

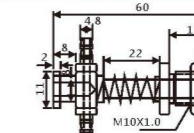

JD11-1060 大头金具

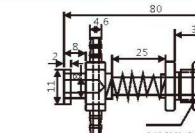

JD11-1080 大头金具

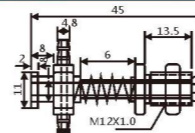

JD11-1245 大头金具

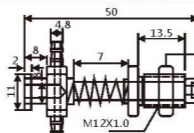

JD11-1250 大头金具

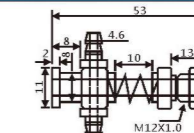

JD11-1253 大头金具

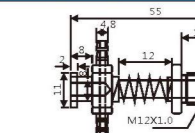

JD11-1255 大头金具

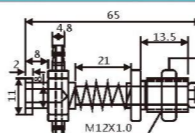

JD11-1265A 大头金具

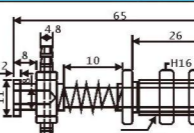

JD11-1265B 大头金具加长牙

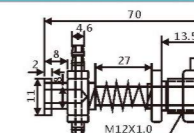

JD11-1270A 大头金具

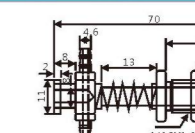

JD11-1270B 大头金具加长牙

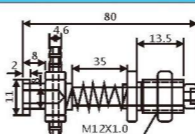

JD11-1280A 大头金具

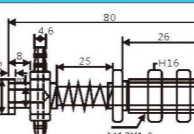

JD11-1280B 大头金具加长牙

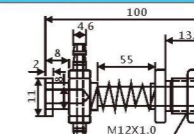

JD11-12100 大头金具

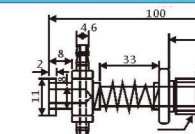

JD11-12100A 大头金具

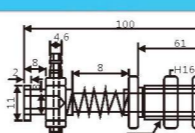

JD11-12100B 大头金具加长牙

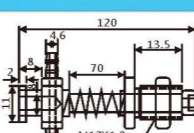

JD11-12120 大头金具

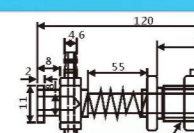



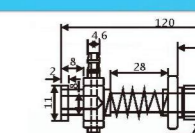

















JD11-12120A 大头金具





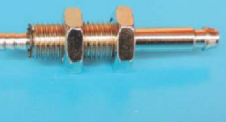

















JD11-12120B 大头金具加长牙



▼ 天行金具系列

 JT11-1245 大头铜金具	 JT11-1255 大头铜金具	 JT11-1265A 大头铜金具	 JT11-1265B 大头铜金具加长牙
 JT11-1280A 大头铜金具	 JT11-1280B 大头铜金具加长牙	 JT11-12100A 大头铜金具	 JT11-12100B 大头铜金具加长牙
 JD07R010 迷你金具B	 JD07R020 迷你金具B1	 JD07R030 迷你金具B2	 JD07R040 迷你金具F
 JD07R050 迷你金具A	 JD07R060 迷你金具A1	 JD07R070 迷你金具A2	 JD07R080 迷你金具E
 YM 45 迷你金具	 YM 56 迷你金具	 YM 61 迷你金具	 YM 85 迷你金具

▼ 后进气金具系列

 JH07-1050 小头后进气金具	 JH07-1060 小头后进气金具	 JH07-1080A 小头后进气金具	 JH07-1080B 小头后进气金具
 JH11-1053 大头后进气金具	 JH11-1253 大头后进气金具	 JH11-1065 大头后进气金具	 JH11-1265 大头后进气金具
 JH11-1080A 大头后进气金具	 JH11-1080B 大头后进气金具	 JH11-1280A 大头后进气金具	 JH11-1280B 大头后进气金具
 JH11-10100A 大头后进气金具	 JH11-10100B 大头后进气金具	 JH11-12100A 大头后进气金具	 JH11-12100B 大头后进气金具
 JH11-10120A 大头后进气金具	 JH11-10120B 大头后进气金具	 JH11-12120A 大头后进气金具	 JH11-12120B 大头后进气金具



后进气金具系列











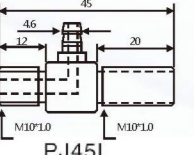

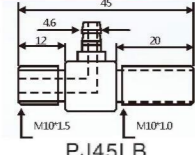

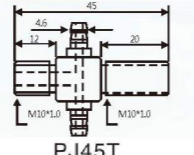

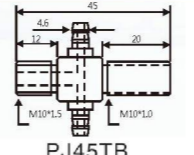

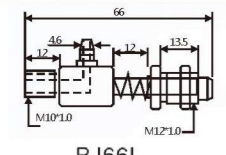

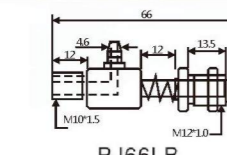

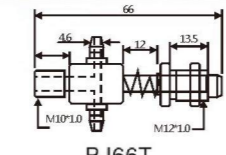

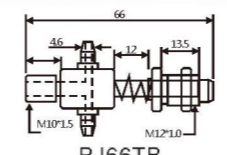

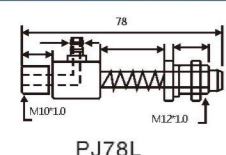

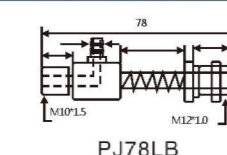

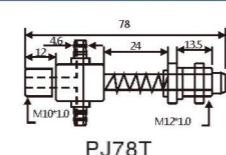

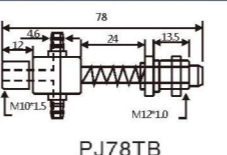

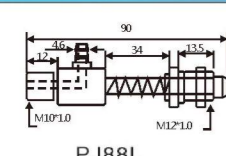

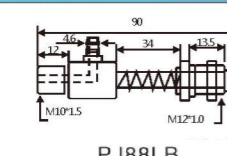
 JH07-1050T	 JH07-1060T	 JH07-1080T	 JH07-10100BT
 JH11-1053T	 JH11-1253T	 JH11-1065T	 JH11-1265T
 JH11-1080BT	 JH11-1280BT	 JH11-10100BT	 JH11-12100BT
 JH11-10120BT	 JH11-12120BT	 JD09-0843 哈模平头金具	 JD05-0848 哈模尖头金具
 JF07-1045 小头防转金具	 JF07-1245 小头防转金具	 JF07-1052 小头防转金具	 JF07-1252 小头防转金具

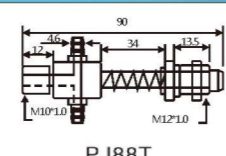
天行防转金具系列

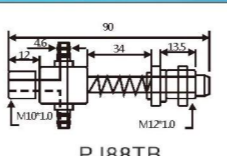

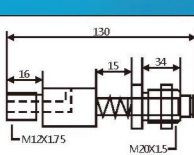

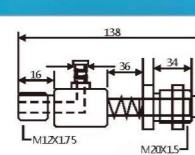

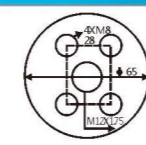
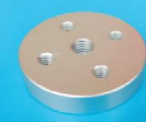
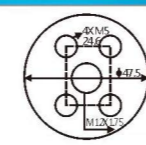



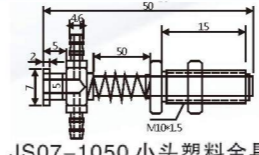

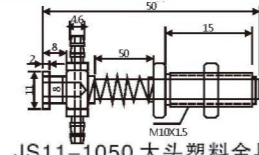

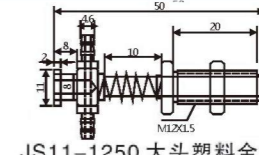

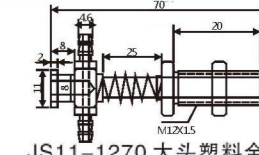

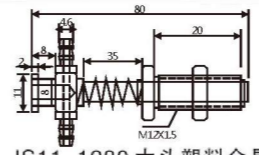

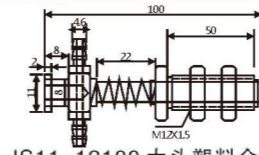

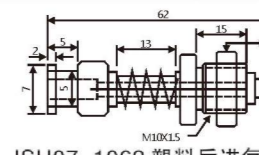

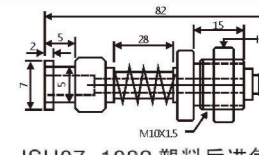

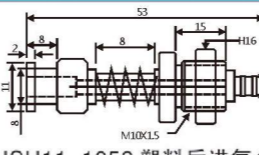

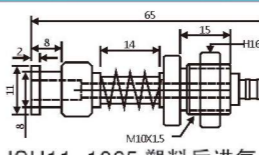

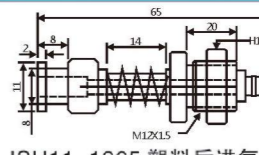

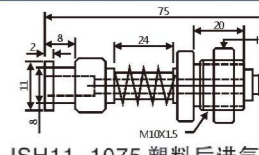

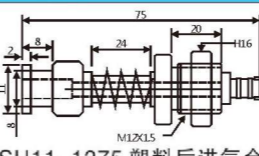

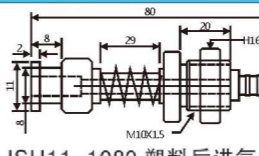

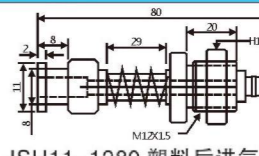
 JF07-1062 小头防转金具	 JF07-1262 小头防转金具	 JF07-1072 小头防转金具	 JF07-1272 小头防转金具
 JF11-1050 大头防转金具	 JF11-1250 大头防转金具	 JF11-1055 大头防转金具	 JF11-1255 大头防转金具
 JF11-1065 大头防转金具	 JF11-1265 大头防转金具	 JF11-1075 大头防转金具	 JF11-1275 大头防转金具
 JFH07-1050 防转后进气金具	 JFH07-1250 防转后进气金具	 JFH07-1060 防转后进气金具	 JFH07-1260 防转后进气金具
 JFH11-1053 防转后进气金具	 JFH11-1063 防转后进气金具	 JFH11-1263 防转后进气金具	 JFH11-1273 防转后进气金具

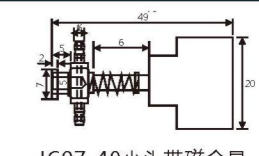

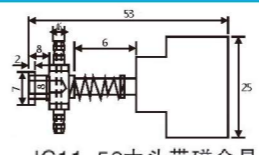
▼ PJ 系列

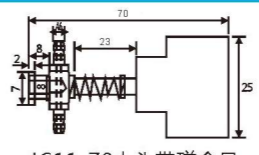

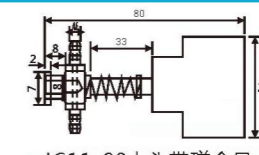

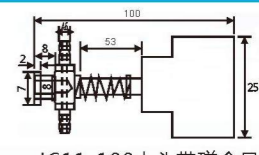









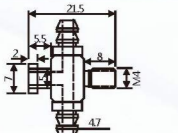
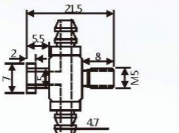
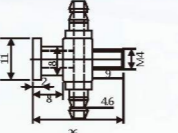
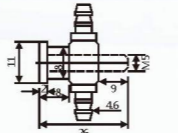



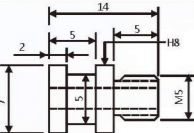
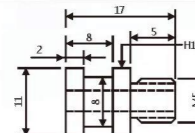
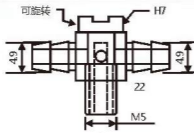
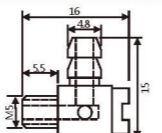

  PJ45L	  PJ45LB	  PJ45T	  PJ45TB
  PJ66L	  PJ66LB	  PJ66T	  PJ66TB
  PJ78L	  PJ78LB	  PJ78T	  PJ78TB
  PJ88L	  PJ88LB	  PJ88T	  PJ88TB
  PJH130L	  PJ138L	  PFG系列吸盘转接座	  HB 系列吸盘转接座

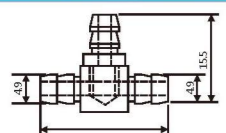
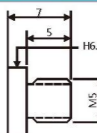
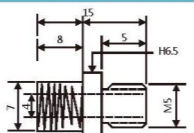
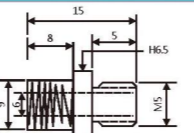
▼ 天行塑料金具系列



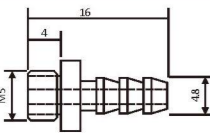
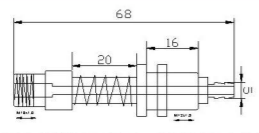
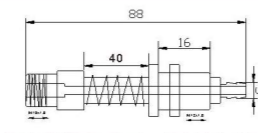
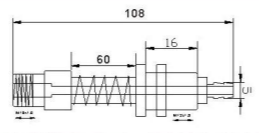



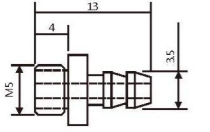
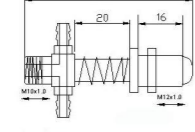
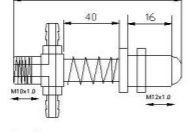
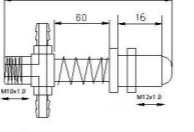







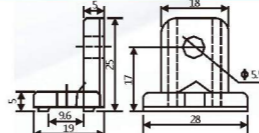
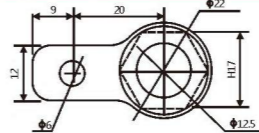
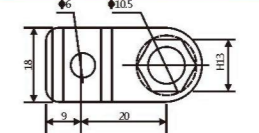
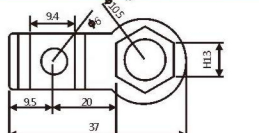



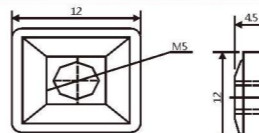
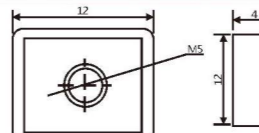
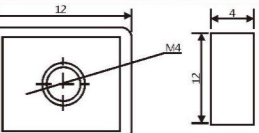
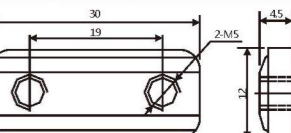

  JS07-1050 小头塑料金具	  JS11-1050 大头塑料金具	  JS11-1250 大头塑料金具	  JS11-1270 大头塑料金具
  JS11-1280 大头塑料金具	  JS11-12100 大头塑料金具	  JSH07-1062 塑料后进气金具	  JSH07-1082 塑料后进气金具
  JSH11-1053 塑料后进气金具	  JSH11-1065 塑料后进气金具	  JSH11-1265 塑料后进气金具	  JSH11-1075 塑料后进气金具
  JSH11-1275 塑料后进气金具	  JSH11-1080 塑料后进气金具	  JSH11-1280 塑料后进气金具	  JC07-49 小头带磁金具
  JC11-53 大头带磁金具	  JC11-70 大头带磁金具	  JC11-80 大头带磁金具	  JC11-100 大头带磁金具

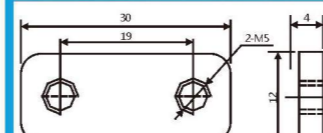
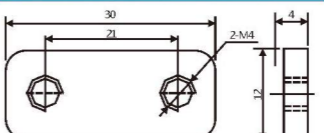
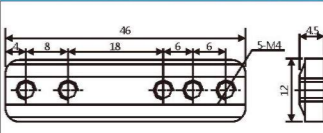
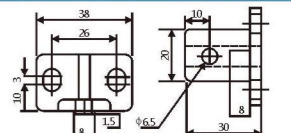

金具系列

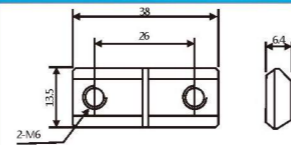
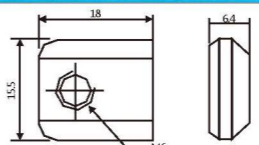
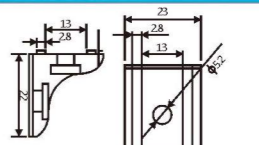
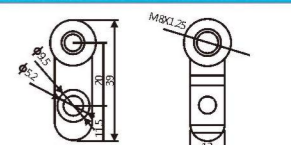
			
			
JD07-04 小头气缸头	JD07-05 小头气缸头	JD11-04 大头气缸头	JD11-05 大头气缸头
			
			
JD07-M5 小头金具转换头	JD11-M5 大头金具转换头	继手T1	继手T2
			
			
继手T3	M5堵头	M5-4快速气嘴	M5-6快速气嘴
			
			
M5-6气嘴	强力后进气金具 JDH10-1260	强力后进气金具 JDH10-1280	强力后进气金具 JDH10-12100
			
			
M5-4气嘴	强力金具 JDM10-1260	强力金具 JDM10-1280	强力金具 JDM10-12100

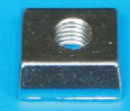
金具系列

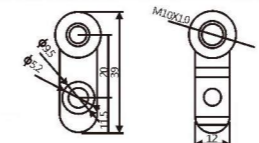
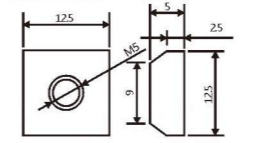
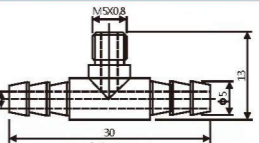
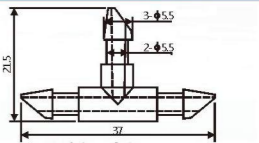
			
			
JD20B010 天行L块	JD20B020 大头金具固定块	JD20B030 小头金具固定块A	JD20B040 小头金具固定块
			
			
JD20B050 锌合金单孔螺母	JD20B060 冲压单孔螺母	JD20B070 冲压单孔螺母	JD20B080 锌合金双孔螺母
			
			
JD20B090 冲压双孔螺母	JD20B100 冲压双孔螺母	JD20B101 五孔螺母	JD20E010 L型固定块
			
			
JD20E020 双孔固定螺母	JD20E030 单孔固定螺母	JD20E040 哈模L块	JD20E050 哈模金具固定块
			
			
JD20E060 海尔金具固定块	JD20E070 海尔单孔螺母	塑料三通	塑料三通



# 治具铝条系列

FIXTURE ALUMINUM BAR SERIES



  万向支架 JD20-20	  万向吸盘支架 JD20-002	  万向支架 JD20-φ12	  万向抱具支架 JD20-MCD
  万向带缓冲支架 JD20-001	  万向带缓冲支架 JD20-003	  万向支架 JD12-φ10	  气缸支架 · φ20
  管道复合夹具D	  管道复合夹具E	 不锈钢管 φ12	 不锈钢管 φ20
  十字连接块 φ12-φ12	  平行连接块 φ12-φ12	  十字连接块 φ12-φ10	  MCD抱具支架 TH · φ12
  滑移40支架 T · φ12	  滑移40支架 W · φ12	  滑移40支架 W · M10	  滑移40支架 W · M12

  十字连接块 φ20-φ20	  十字连接块 φ20-φ12	  附加支架 φ20 · M8	  滑移70支架 W · φ20
  平行连接块 φ20-φ20	  MCD抱具支架 T · φ20	  MCD抱具支架 TH · φ20	  MCD抱具支架 TV · φ20
  T字连接块#2 φ20 φ20	  旋转支架 φ20 20A	  套筒螺母 φ20 M12	  滑移40支架 W - D20 · M6
  连接支架 φ12-M6	  T字连接块#2 φ12 φ12	  旋转支架 φ12 · 12A	  旋转支架 M12 · 12A
  滑移支架 W-φ12	  不锈钢管端盖 φ12	  不锈钢管端盖 φ20	  天行铝条A端盖



# 治具铝条系列

FIXTURE ALUMINUM BAR SERIES

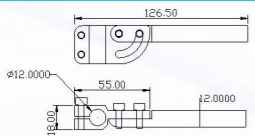
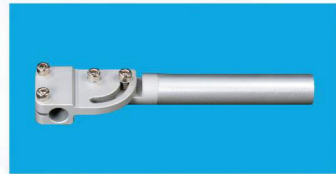

万向可调支架 JD12-H12

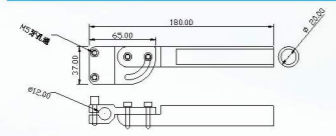
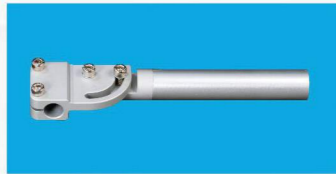

万向可调支架 JD12-H20

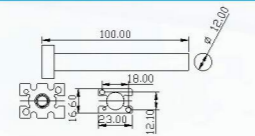
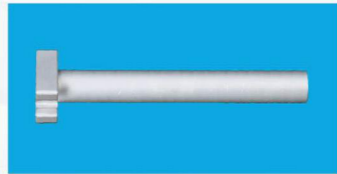

气动手指固定支架 JD-M10

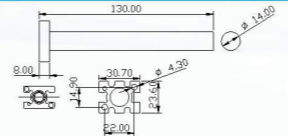

气动手指固定支架 JD-M16

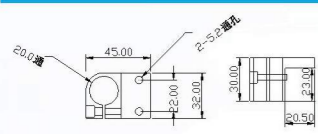

铝条固定支架 JD25-Φ20

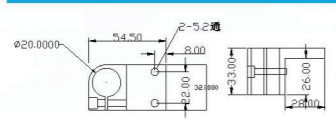

铝条固定支架 JD40-Φ20

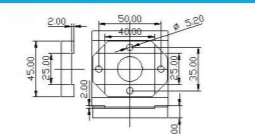
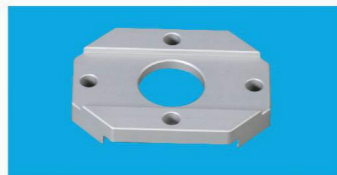

铝条固定支架 JD25-40

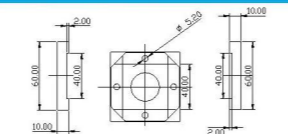

铝条固定支架 JD40-40

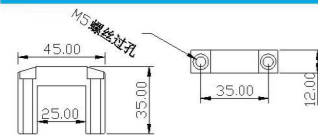

铝条固定支架 JD-25

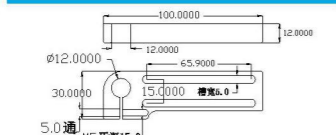

固定支架 JD-A12

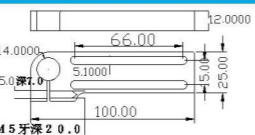

固定支架 JD-A14

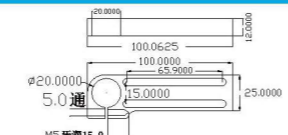
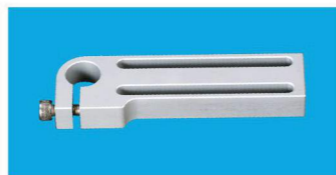

固定支架 JD-A20

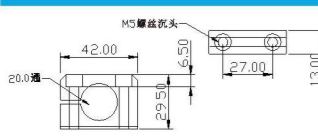
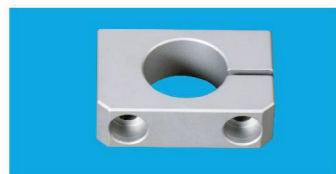

固定支架 JD-Φ20

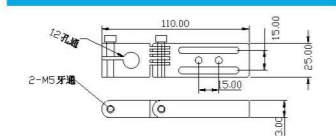

角度调整链接件 JD-D12

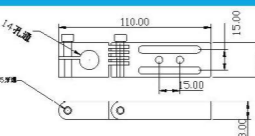

角度调整链接件 JD-D14

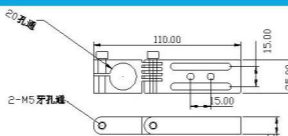

角度调整链接件 JD-D20

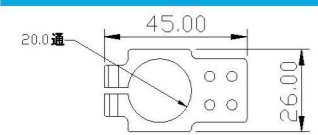
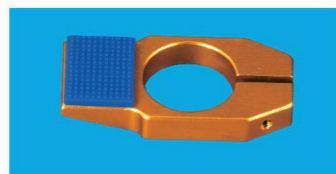

管道夹具垫片

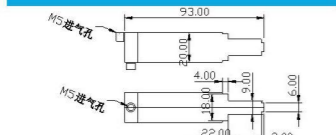

顶出节吸金具 JD20-H90

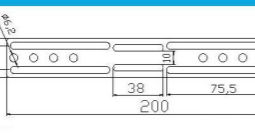
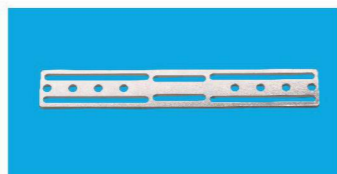

吸盘治具H JD20C090

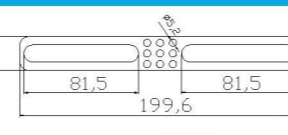
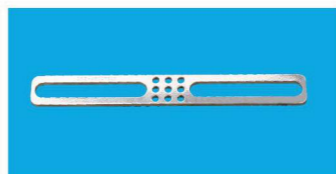

吸盘治具E JD20C100

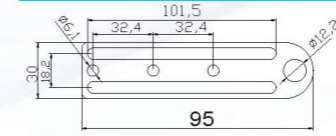
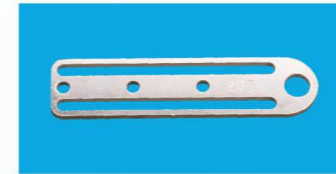

金具固定板E JD20E-093

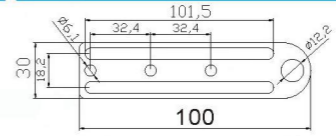
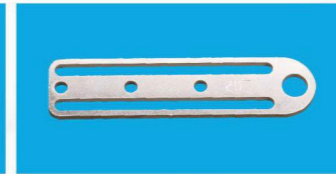

金具固定板F JD20E-094

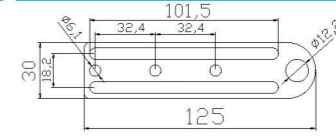
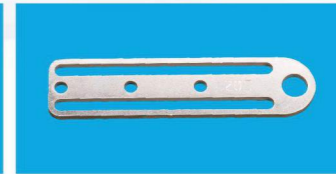

金具固定板G JD20E-095

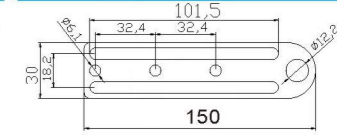
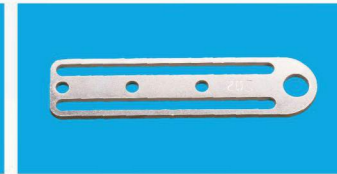

金具固定板H JD20E-096

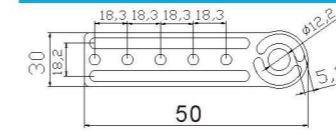

双槽迷你夹具支架 JD20E-097

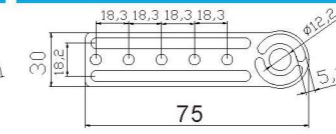
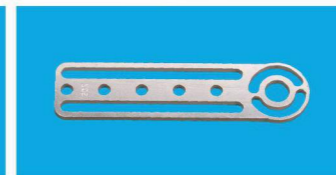

双槽迷你夹具支架 JD20E-098

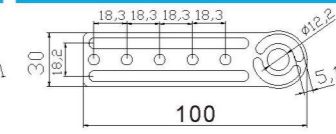
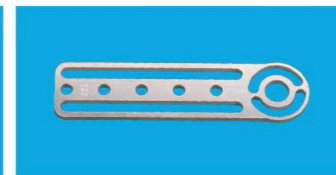

双槽迷你夹具支架 JD20E-099

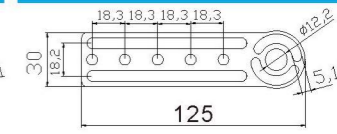
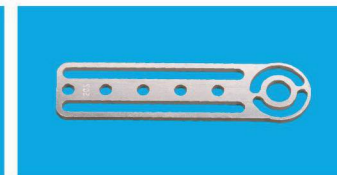

双槽迷你夹具支架 JD20E-100

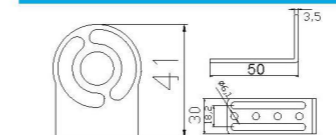

双槽迷你支架L型支架 JD20E-101

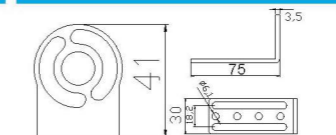

双槽迷你支架L型支架 JD20E-102

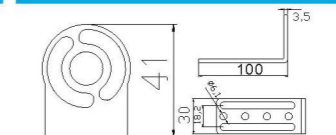

双槽迷你支架L型支架 JD20E-103

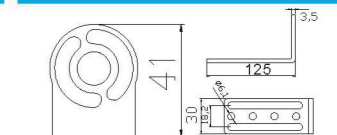

双槽迷你支架L型支架 JD20E-104

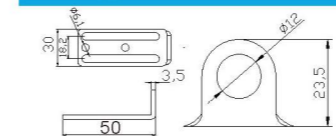

双槽金具L型支架 JD20E-105

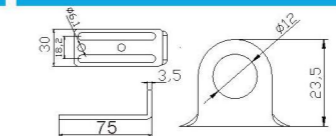

双槽金具L型支架 JD20E-106

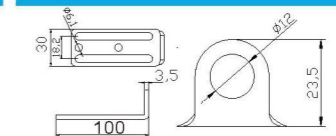

双槽金具L型支架 JD20E-107

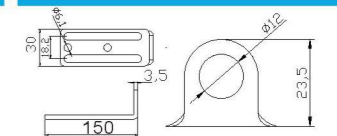

双槽金具L型支架 JD20E-108

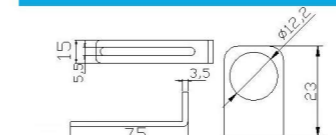
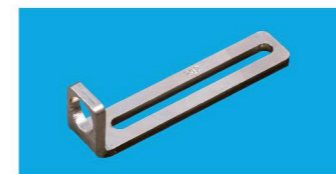

单槽金具L型支架 JD20E-109

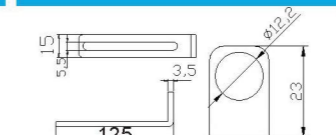

单槽金具L型支架 JD20E-110

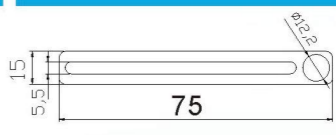
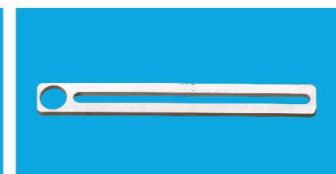

单槽金具平面支架 JD20E-111

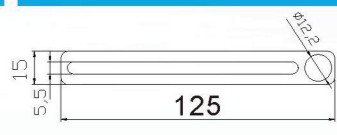
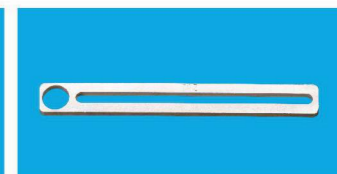

单槽金具平面支架 JD20E-112



# 治具铝条系列

FIXTURE ALUMINUM BAR SERIES

# ROBTECH

JD20E080 金具固定板A	JD20E090 金具固定板B	金具固定板C JD20E091	金具固定板D JD20E092
治具块A JD20C039A	JD20C040 治具块A(带牙)	JD20C050 治具块A(通2孔)	JD20C060 治具块A(通6孔)
JD20C070 吸盘治具板A	JD20C030 治具块B(通孔)	JD20C010 治具块B(带牙)	JD20C020 治具块B(通孔)
JD20C080 吸盘治具板B	JD30F001 天行铝条A	JD30F002 天行铝条B	JD30F003 天行铝条C
JD30F004 天行铝条D	JD30F006 哈模铝条	JD30F005 单槽铝条	JD30F007 海尔铝条

JD20F001 上下缓冲挡块	JD20F002 引拨挡块	JD20F003 双节上下缓冲挡块	JD20F004 单节引拨气缸挡块
JD20F005 单节引拨缓冲座	JD20F006 单节引拨固定座	JD20F010 皮带固定座	JD20F011 皮带压块
JD20F007 双节引拨气缸固定块	JD20F008 双节引拨固定座	JD20F009 双节缓冲座	上下气缸固定块
JD20F012 气排-4	JD20F013 气排-6	JD20F014 气排-8	JD20F015 气排-10
JD30F011 有信铝条A	JD20F30 角度调整架	吸盘治具A	吸盘治具B
方形铝条角码	JD30F2020 方形铝条	JD30F2525 方形铝条	JD30F3030 方形铝条



# 治具铝条系列

FIXTURE ALUMINUM BAR SERIES

# 剪刀系列

SCISSORS SERIES

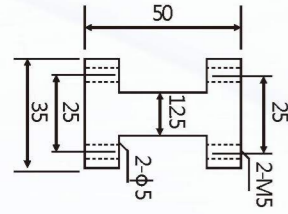
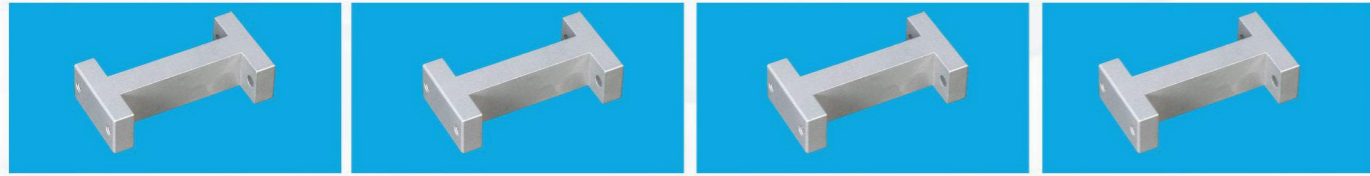

小夹具连接工字架50mm

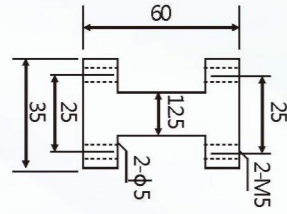

小夹具连接工字架60mm

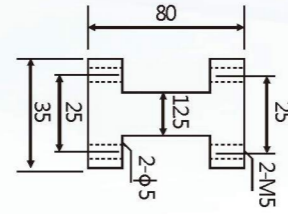

小夹具连接工字架80mm

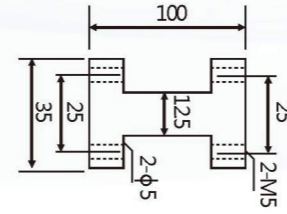

小夹具连接工字架100mm

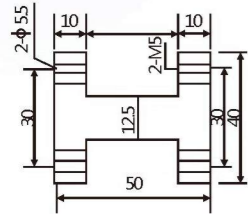
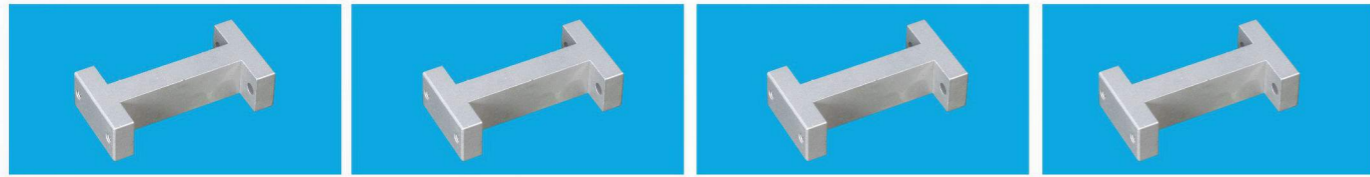

大夹具连接工字架50mm

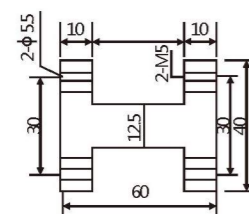

大夹具连接工字架60mm

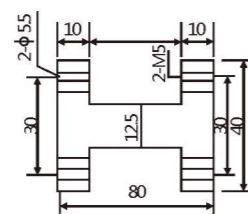

大夹具连接工字架80mm

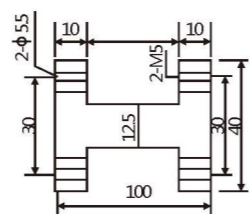

大夹具连接工字架100mm

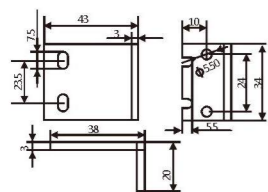

小夹具连接L块43mm

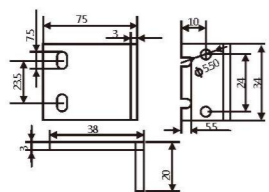

小夹具连接L块75mm

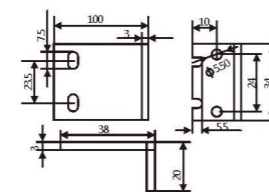

小夹具连接L块100mm

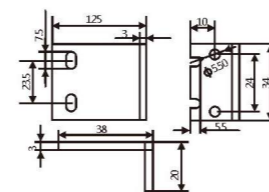

小夹具连接L块125mm

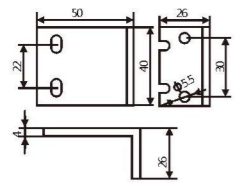

大夹具连接L块50mm

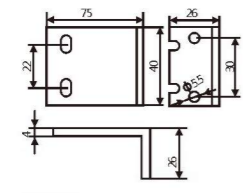

大夹具连接L块75mm

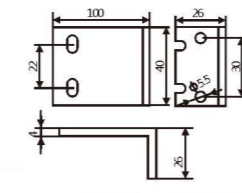

大夹具连接L块100mm

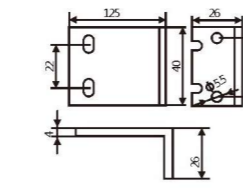

大夹具连接L块125mm

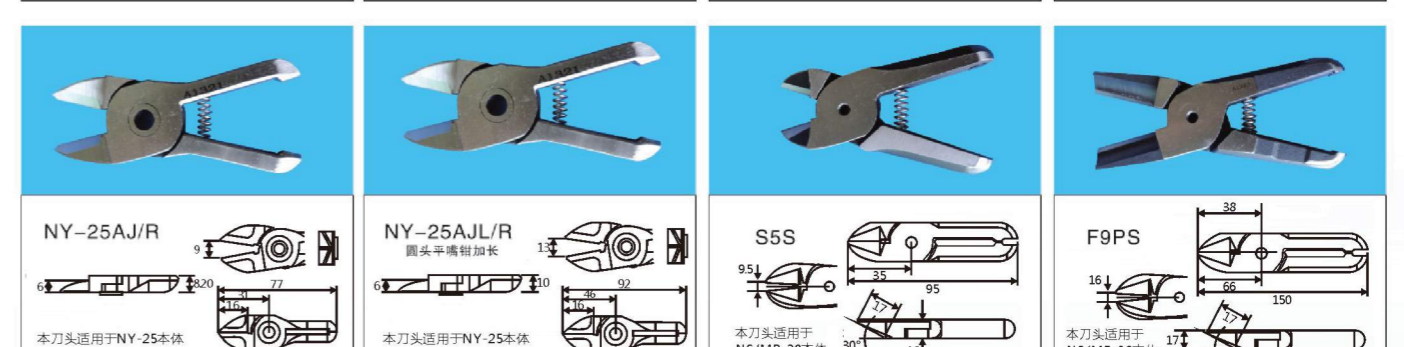
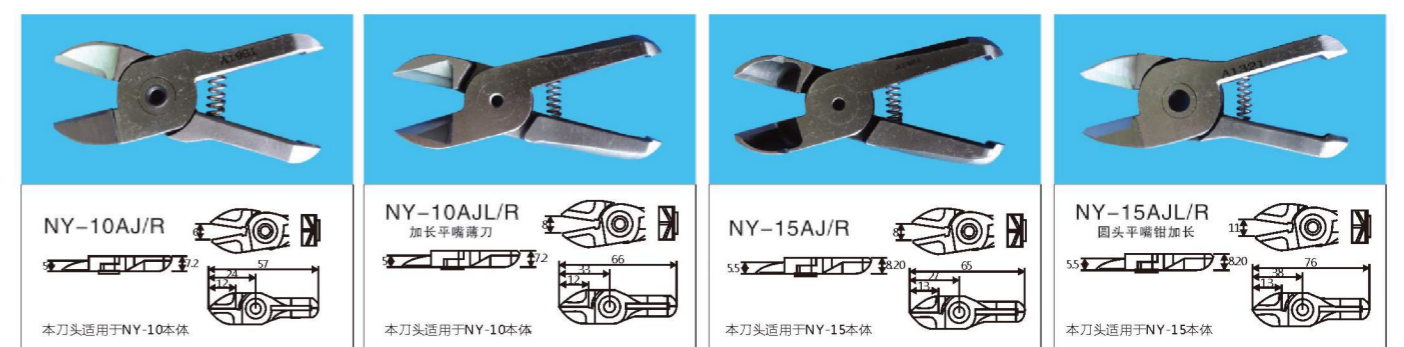
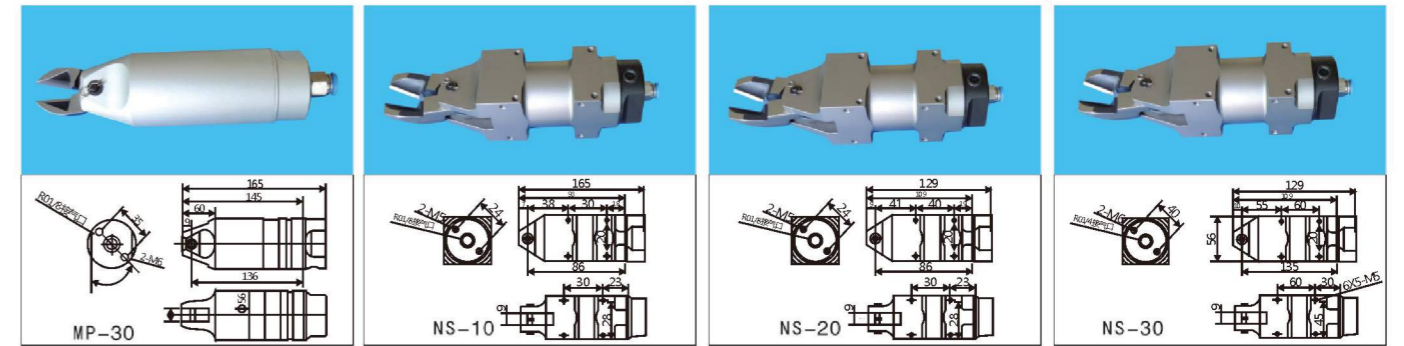
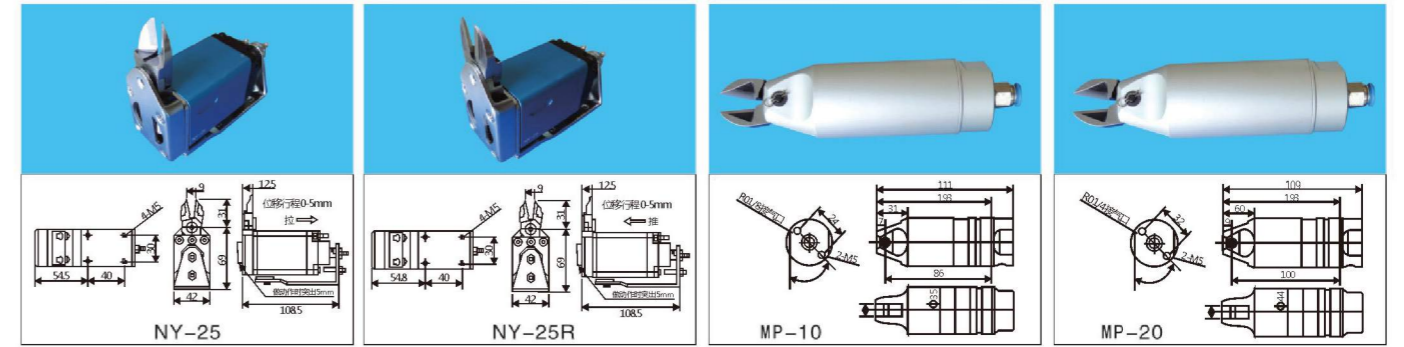
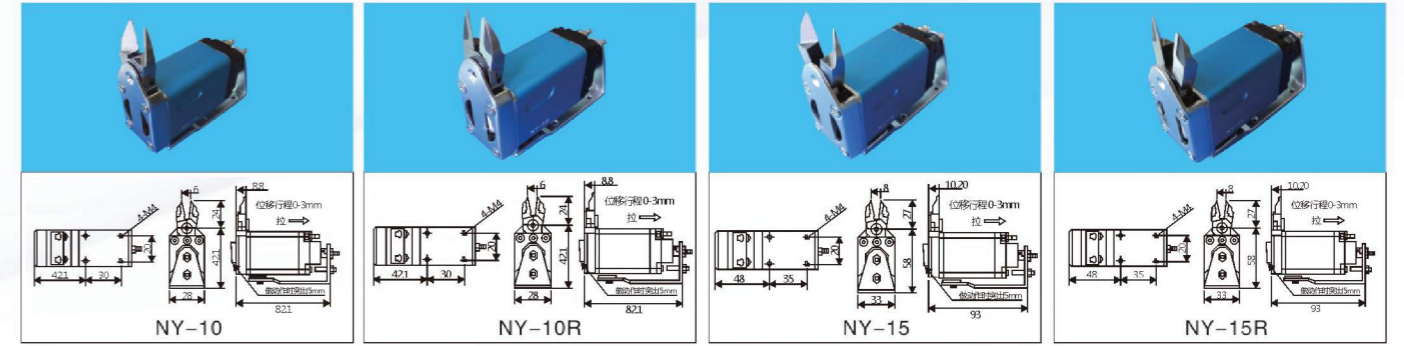



# 剪刀系列

SCISSORS SERIES

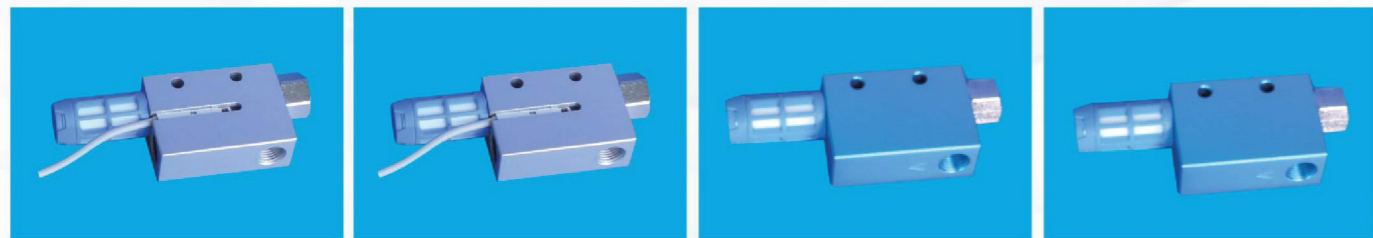

真空发生器CN-10

真空发生器CN-15

真空发生器CV-10

真空发生器CV-15

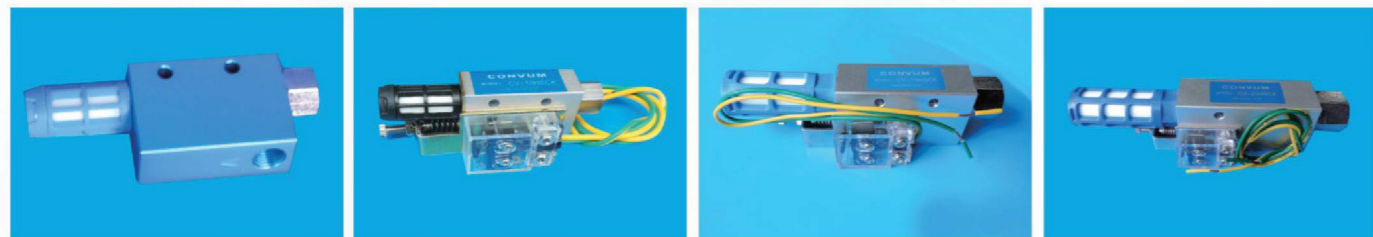

真空发生器CV-20

真空发生器CV-10HSCK

真空发生器CV-15HSCK

真空发生器CV-20HSCK

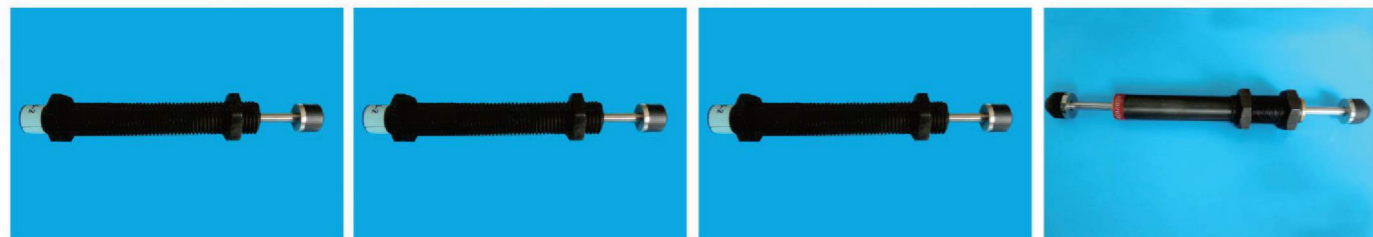

缓冲器AC-1416-2

缓冲器AC-2030-2

缓冲器AC-2050-2

缓冲器ACD-2030-2

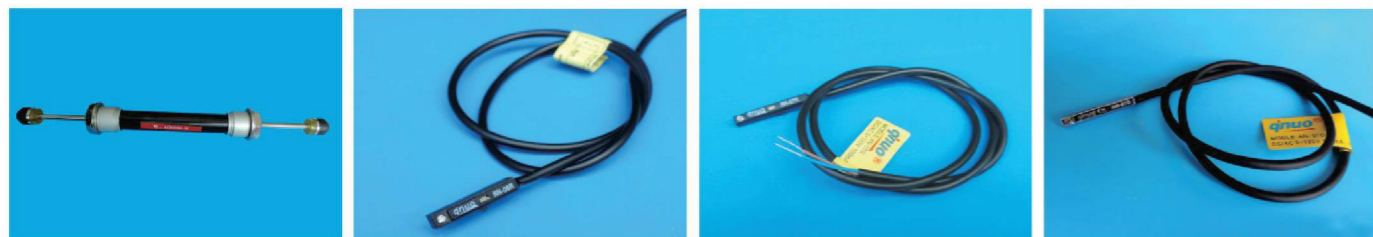

缓冲器ACD-2050W

磁性开关AN-06R

磁性开关AN-07R

磁性开关AN-07D



磁性开关AN-9D

磁性开关AN-21R

抱具微动小开关

抱具微动大开关



抱具治具

直径20圆管治具

圆管治具

万向治具

# 气缸系列

CYLINDER SERIES



防落气缸 20x15

防落气缸 20x20

哈模防落气缸 20x20

测资气缸 32x40

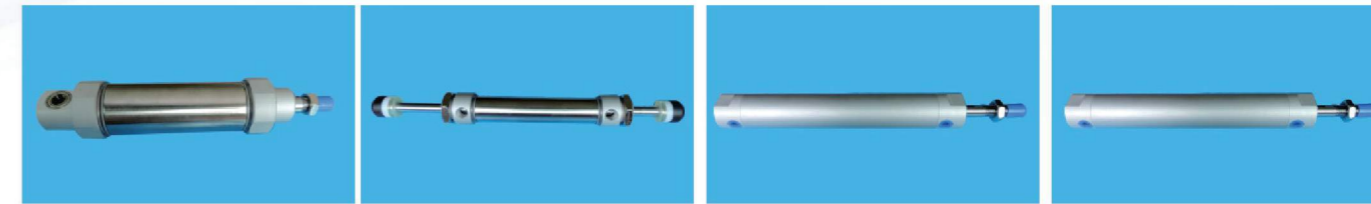

旋出入气缸 40x125

缓冲气缸 20x70

引拔气缸 20x120

引拔气缸 20x150

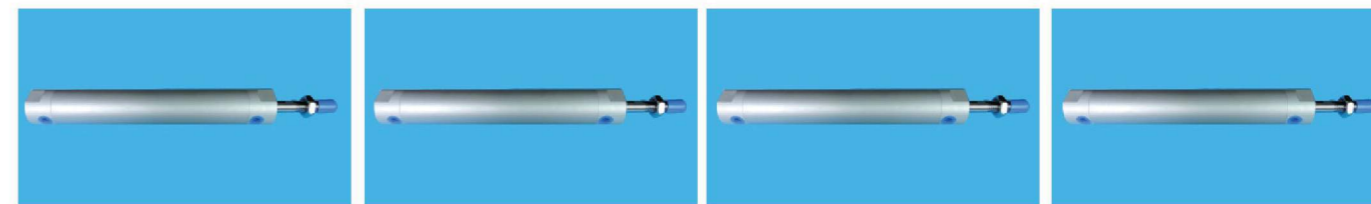

引拔气缸 20x170

引拔气缸 20x200

引拔气缸 25x120

引拔气缸 25x150

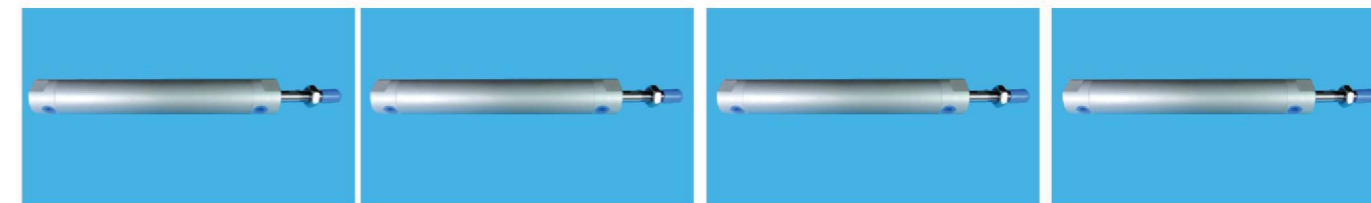

引拔气缸 25x250

引拔气缸 25x300

上下气缸25x550

上下气缸25x650

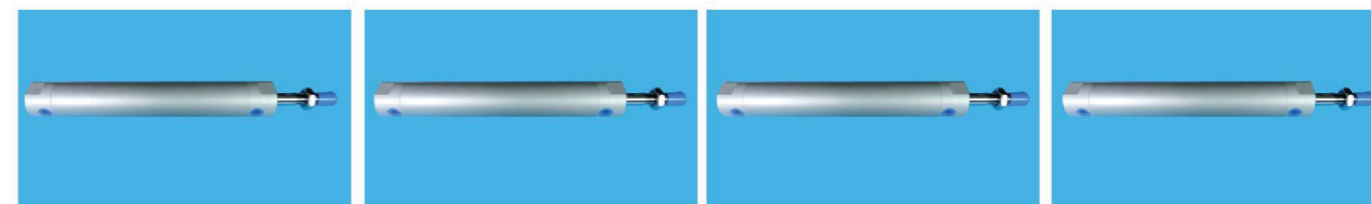

上下气缸25x750

上下气缸25x850

上下气缸32x300

上下气缸32x350

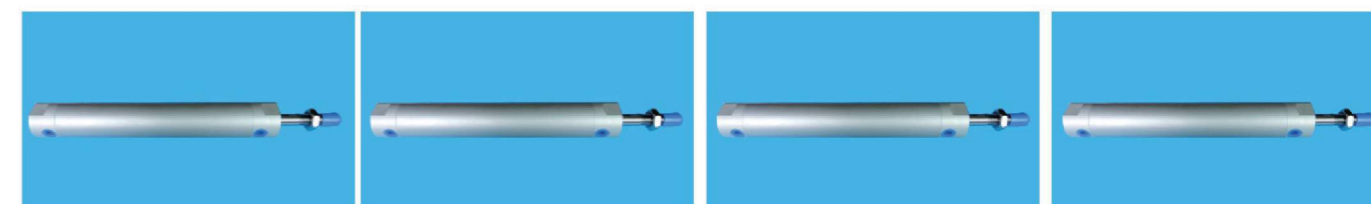

上下气缸32x400

上下气缸32x450

上下气缸32x500

上下气缸32x550

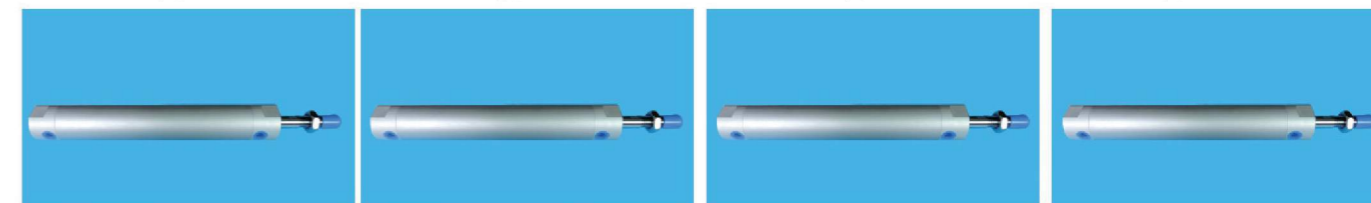

上下气缸32x650

上下气缸32x750

上下气缸32x800

上下气缸32x850



▼ 哈模系列

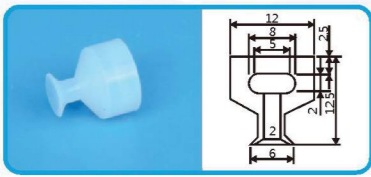

HM1-6

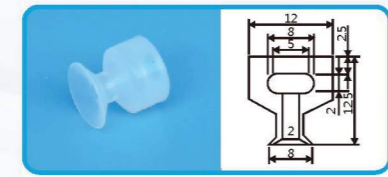

HM1-8

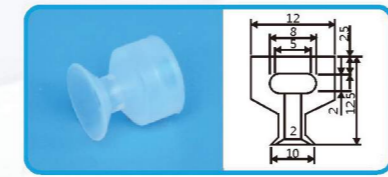

HM1-10

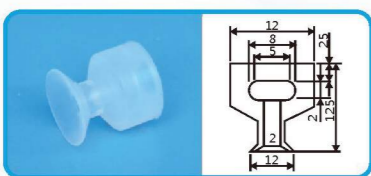

HM1-12



HM1-15

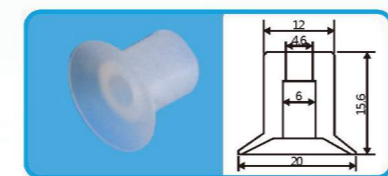

HM1-20

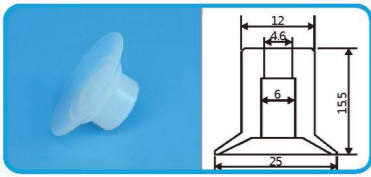

HM1-25

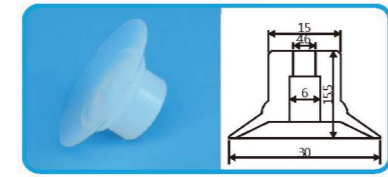

HM1-30

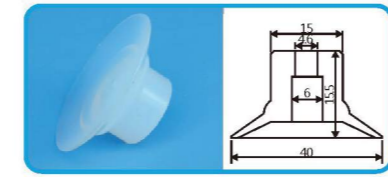

HM1-40

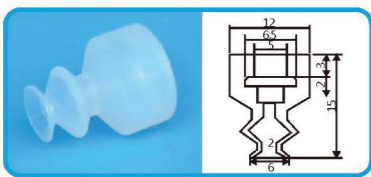

HM2-6



HM2-8



HM2-10

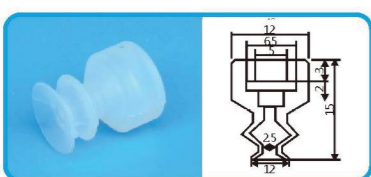

HM2-12

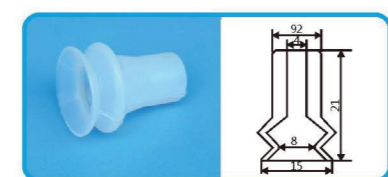

HM2-15

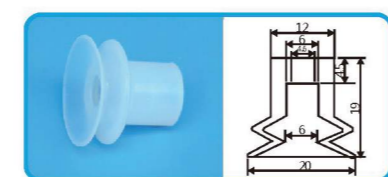

HM2-20

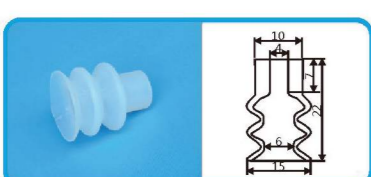

HM3-15

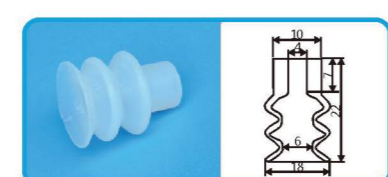

HM3-18



HM3-20

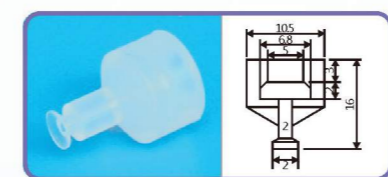

TSL-2

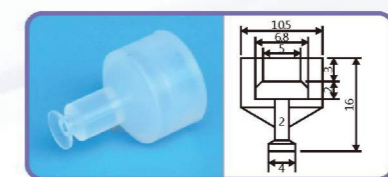

TSL-4

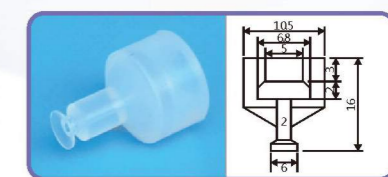

TSL-6

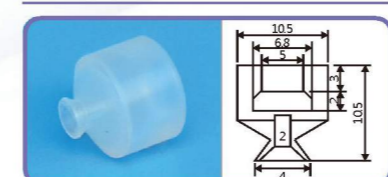

TS1-S4

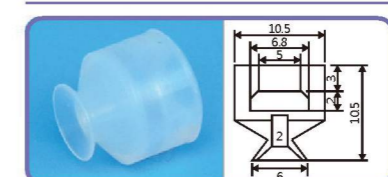

TS1-S6

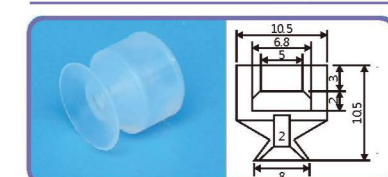

TS1-S8

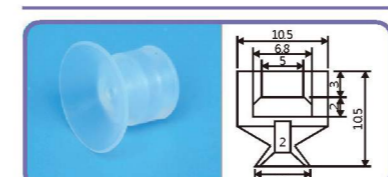

TS1-S10

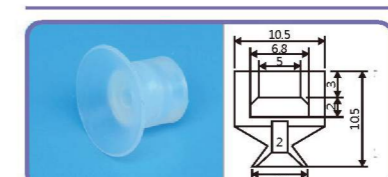

TS1-S12

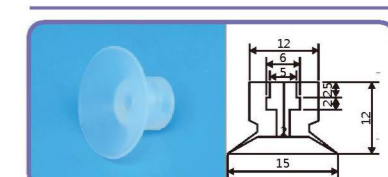

TS1-S15

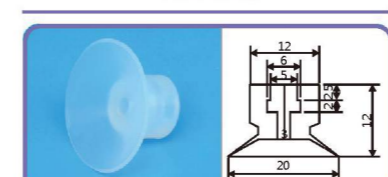

TS1-S20

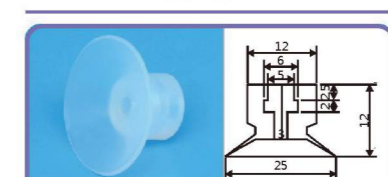

TS1-S25

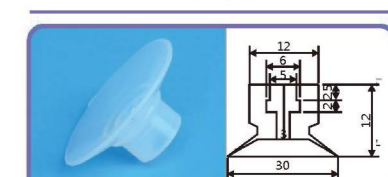

TS1-S30



TS2-S6



TS2-S8



TS2-S10



TS2-S12



TS2-S15



TS2-S20



TS3-S4



TS3-S6



TS3-S8



TS3-S10



TS3-S12



TS3-S15

▼ 天行小头一层吸盘

▼ 天行小头二层吸盘

▼ 天行小头三层吸盘



# 吸盘系列

SUCTION CUP SERIES



▼ 天行大头一层吸盘

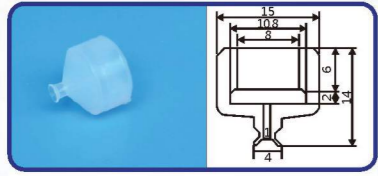

TS1-4

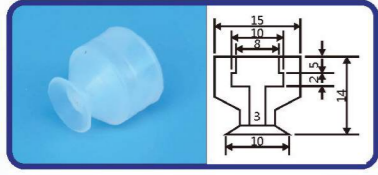

TS1-10

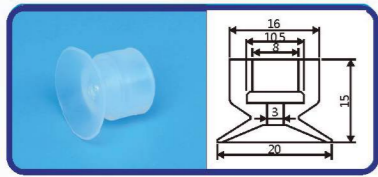

TS1-20

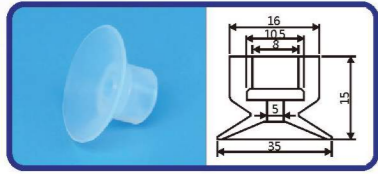

TS1-35

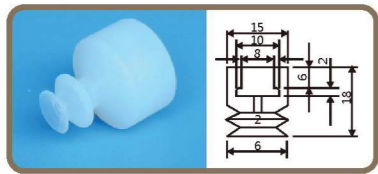

TS2-6

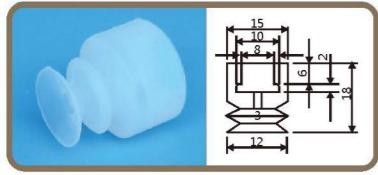

TS2-12

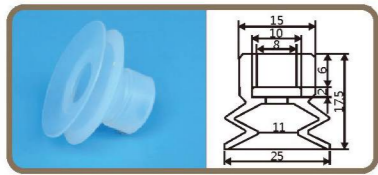

TS2-25

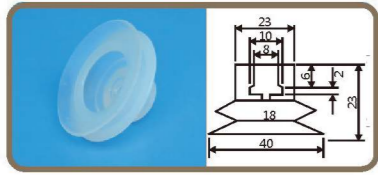

TS2-40

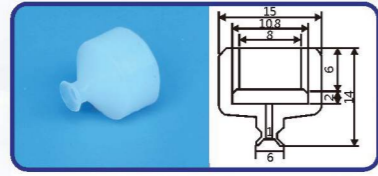

TS1-6

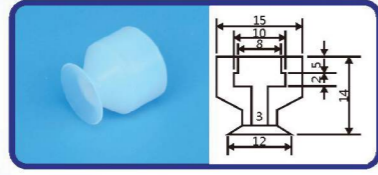

TS1-12

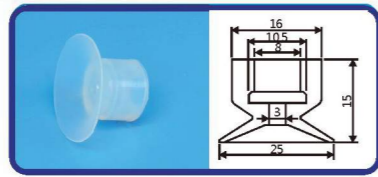

TS1-25

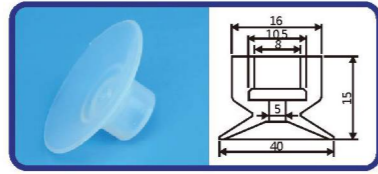

TS1-40

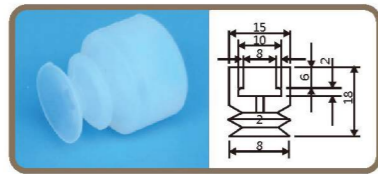

TS2-8

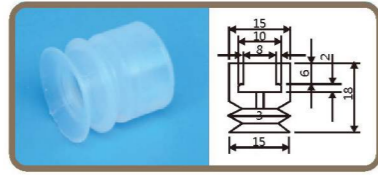

TS2-15

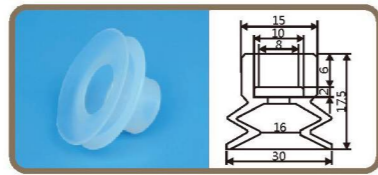

TS2-30

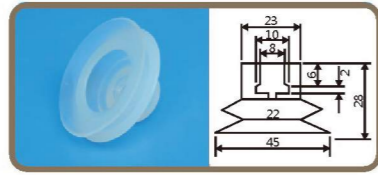

TS2-45

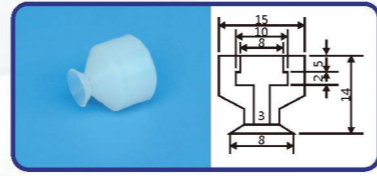

TS1-8

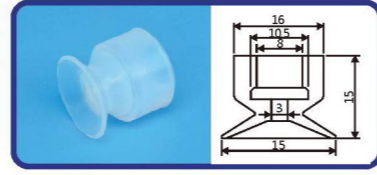

TS1-15

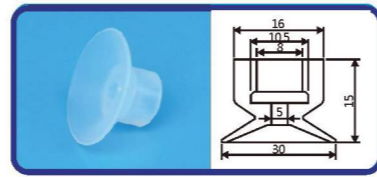

TS1-30

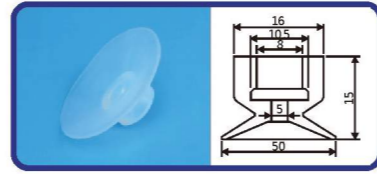

TS1-50

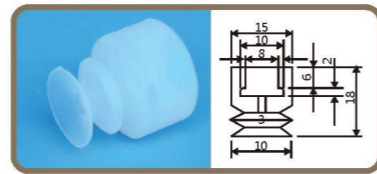

TS2-10

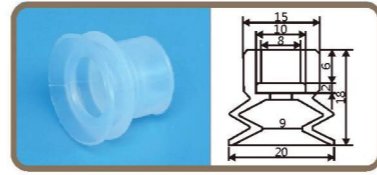

TS2-20

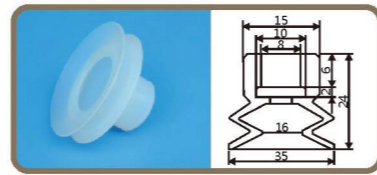

TS2-35

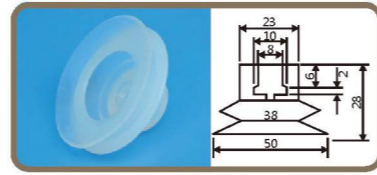

TS2-50

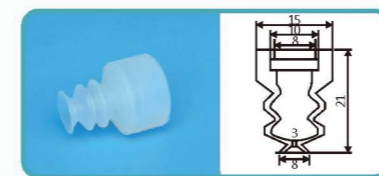

TS3-8

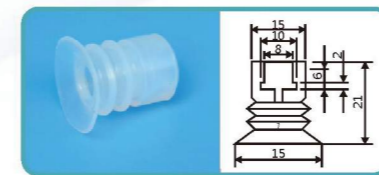

TS3-15

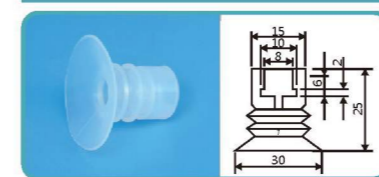

TS3-30

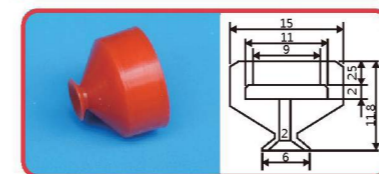

YX1-6

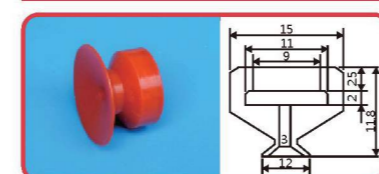

YX1-12

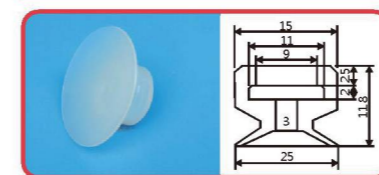

YX1-25

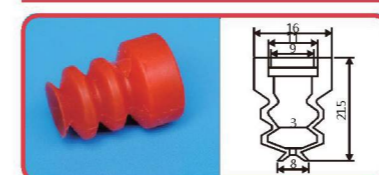

YX3-8

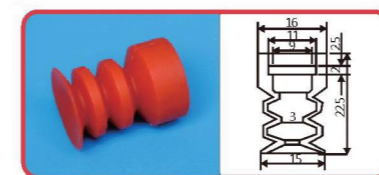

YX3-15

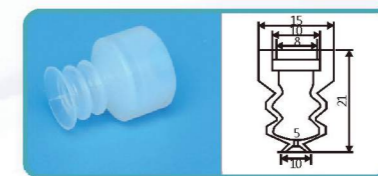

TS3-10

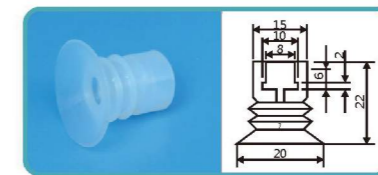

TS3-20

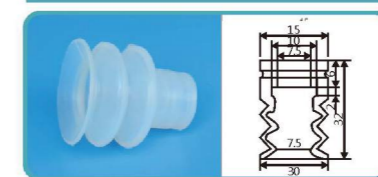

TS3-30B

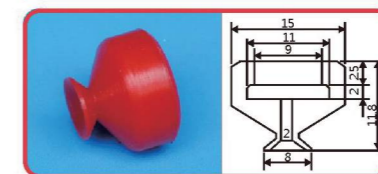

YX1-8

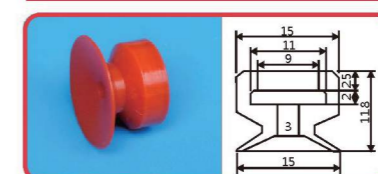

YX1-15

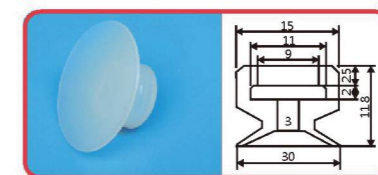

YX1-30

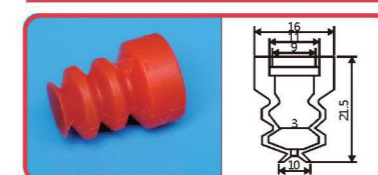

YX3-10

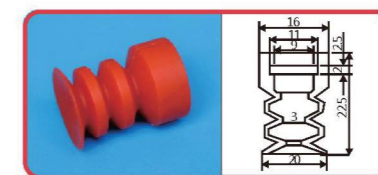

YX3-20



TS3-12

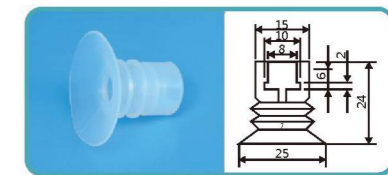

TS3-25



高温海绵吸盘

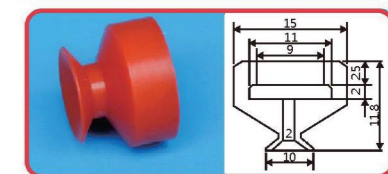

YX1-10

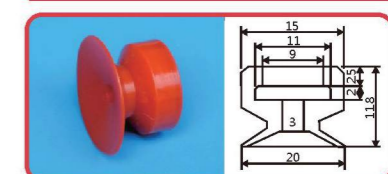

YX1-20

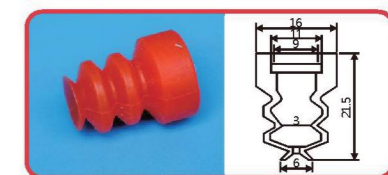

YX3-6

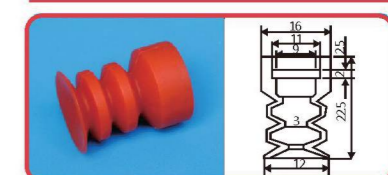

YX3-12

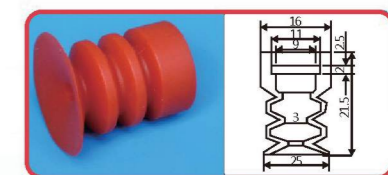

YX3-25

▼ 天行大头三层吸盘

▼ 有信系列

▼ 天行大头二层吸盘



# 吸盘系列

SUCTION CUP SERIES



▼ SD 系列

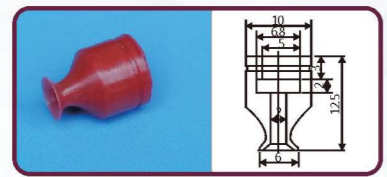

SD1-6 白和红

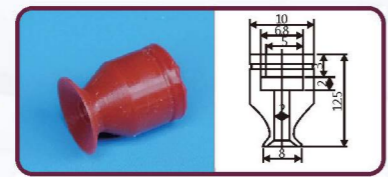

SD1-8 白和红

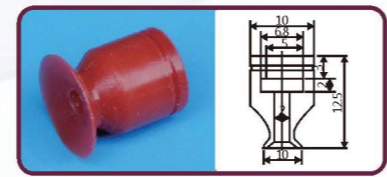

SD1-10 白和红

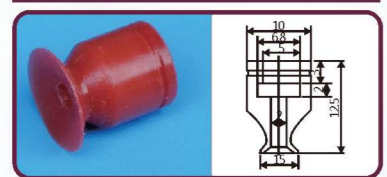

SD1-15 白和红

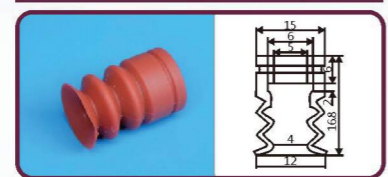

SD3-12 白和红

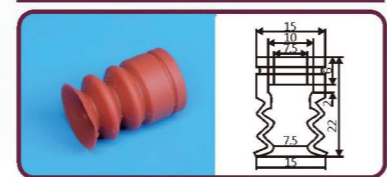

SD3-15 白和红

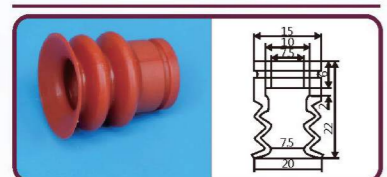

SD3-20 白和红

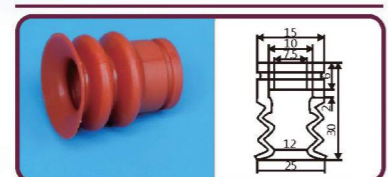

SD3-25 白和红

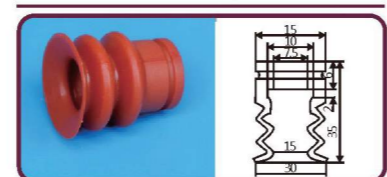

SD3-30 白和红

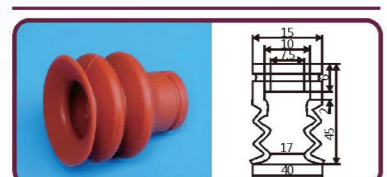

SD3-40 白和红

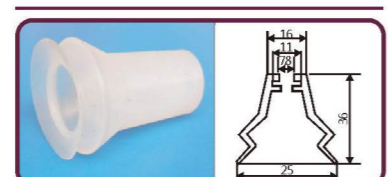

JD2-25 瓶坯吸盘

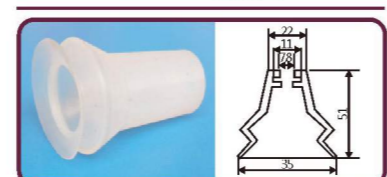

JD2-35 瓶坯吸盘

▼ 迷你系列

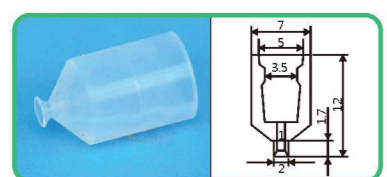

ZP-2

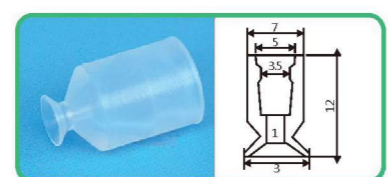

ZP-3

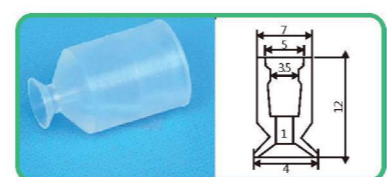

ZP-4

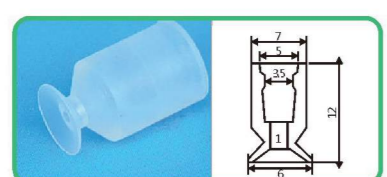

ZP-6

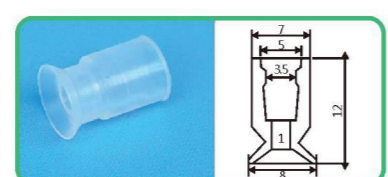

ZP-8

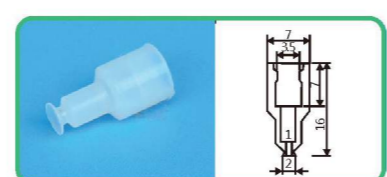

ZPL-2

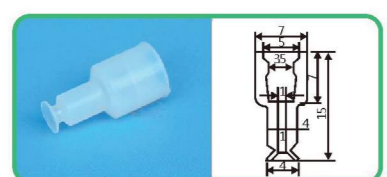

ZPL-4

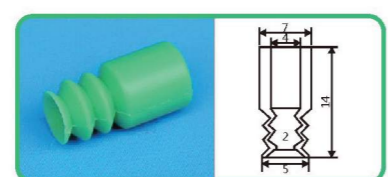

BT-5 白和绿

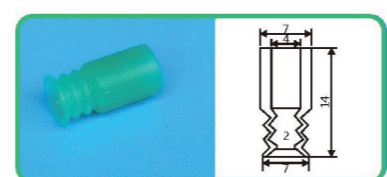

BT-7 白和绿

▼ PJ 系列

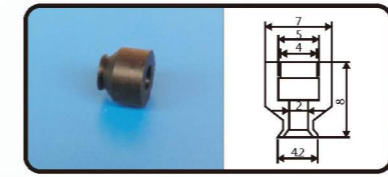

PF-4 白和黑

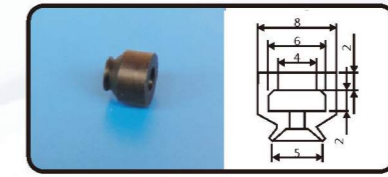

PF-5 白和黑

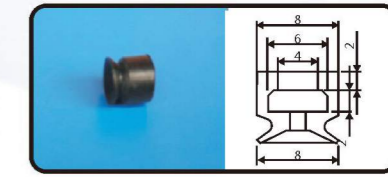

PF-8 白和黑

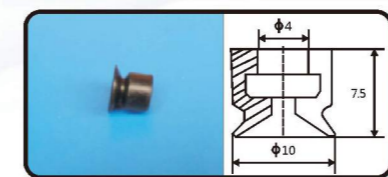

PF-10 白和黑

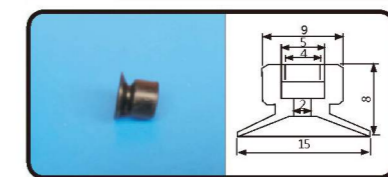

PF-15 白和黑

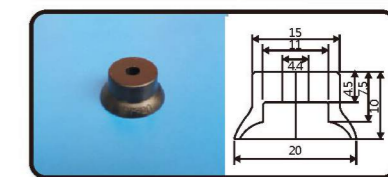

PF-20 白和黑

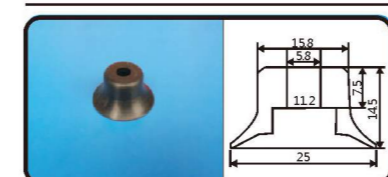

PF-25 白和黑

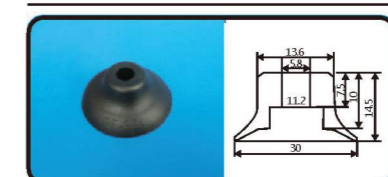

PF-30 白和黑

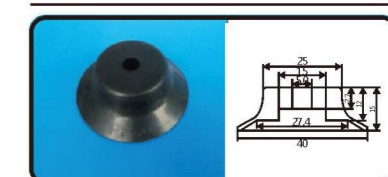

PF-40 白和黑



PF-50 白和黑

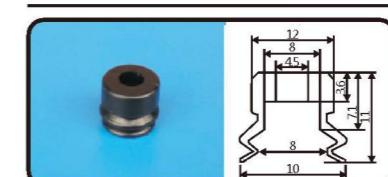

PJG-10 白和黑

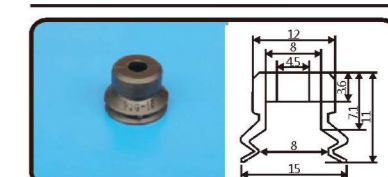

PJG-15 白和黑

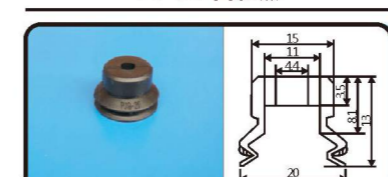

PJG-20 白和黑

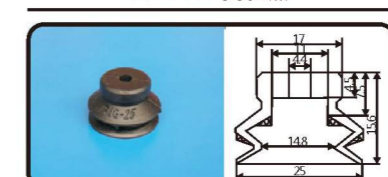

PJG-25 白和黑

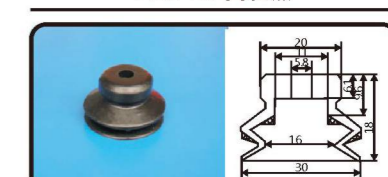

PJG-30 白和黑

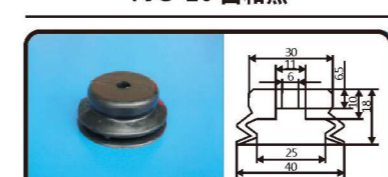

PJG-40 白和黑

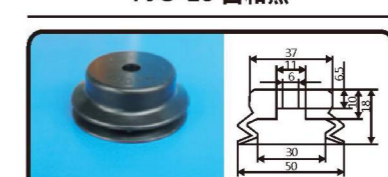

PJG-50 白和黑

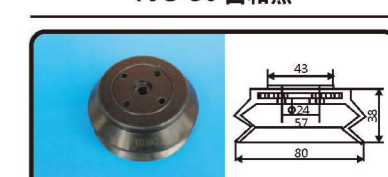

HB-80 白和黑



PF-60 白和黑



PF-80 白和黑

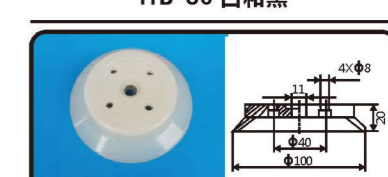

PF-100 白和黑



PF-120 白和黑



PF-150 白和黑



PF-200 白和黑



# 吸盘系列

SUCTION CUP SERIES

